

# LFX NEON SERIES 08 SPEC SHEET



LFX-N-08 -MONO 48V





YYZ LFX Neon series is designed to provide a very bright, crisp consistent and homogenized illumination that will accentuate any building, structure, or artistic flourish. Using high brightness surface mounted LEDs, behind a first-class eco-friendly UV-resistant Silicone polymer encapsulated flexible chamber material, the LFX Neon will provide your project with bright, consistent traces of light in shades of White, single colors. The fixture consists of uniform and even lighting with no Led hotspot. LFX Neon has a transverse minimum radius of 75mm and is horizontal bendable. Easy to install, can be cut and reconnected with IP68 protected connector. The product is supplied in 5m standard rolls or custom as needed.



## SPECIFICATION

OPERATING VOLTAGE	48V DC
POWER	10W / m (3W / ft)
LED COUNT	120LEDs/m (36LEDs / ft)
CUTTING UNIT	12 LEDs
CUTTING LENGTH	100 mm (3.94 in)
MIN. BEND DIA.	150mm (5.9 in)
LED SOURCE	SMD LED 2835
CCT	2200K, 2700K, 3000K, 3500K, 4000K, 4500K, 5000K, 6500K, Green, Blue, Lemon Yellow, Pink
CRI	>80, >90
BINNING	One Bin
MAX. RUN LENGTH	49.2 ft / 15 m(Single Feed), 98.4 ft / 30 m (Double Feed)
BEAM ANGLE	120°
LAMP LIFE	70, 000 hoursL70@25°C, 50, 000 hours L70@50°C
MATERIAL	Silicone
OPERATING TEMP	-40°C to +55°C
IP RATING	IP68
IK RATING	IK08
WARRANTY	5 years

-  **SMD LED 2835**  
LED Quality
-  **48V DC**  
Working Voltage
-  **10W/m**  
Rated power

## DELIVERED LUMENS BY CCT

Color	lm / m	lm/ft
2200K	544 lm/m	166 lm/ft
2700K	553 lm/m	169 lm/ft
3000K	662 lm/m	202 lm/ft
3500K	630 lm/m	192 lm/ft
4000K	648 lm/m	198 lm/ft
4500K	640 lm/m	195 lm/ft
5000K	647 lm/m	197 lm/ft
6500K	660 lm/m	201 lm/ft
Green	440 lm/m	134 lm/ft
Blue	62 lm/m	19 lm/ft
Lemon Yellow	360 lm/m	110 lm/ft
Pink	70 lm/m	22 lm/ft

## DIMENSION

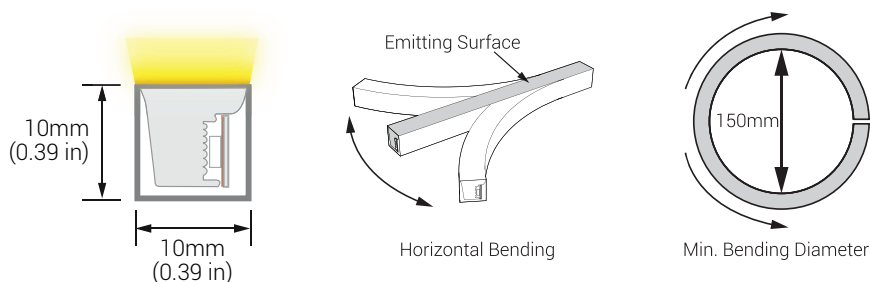

# LFX NEON SERIES 08 SPEC SHEET

LFX-N-08 -MONO 48V

## CONNECTION DIAGRAM

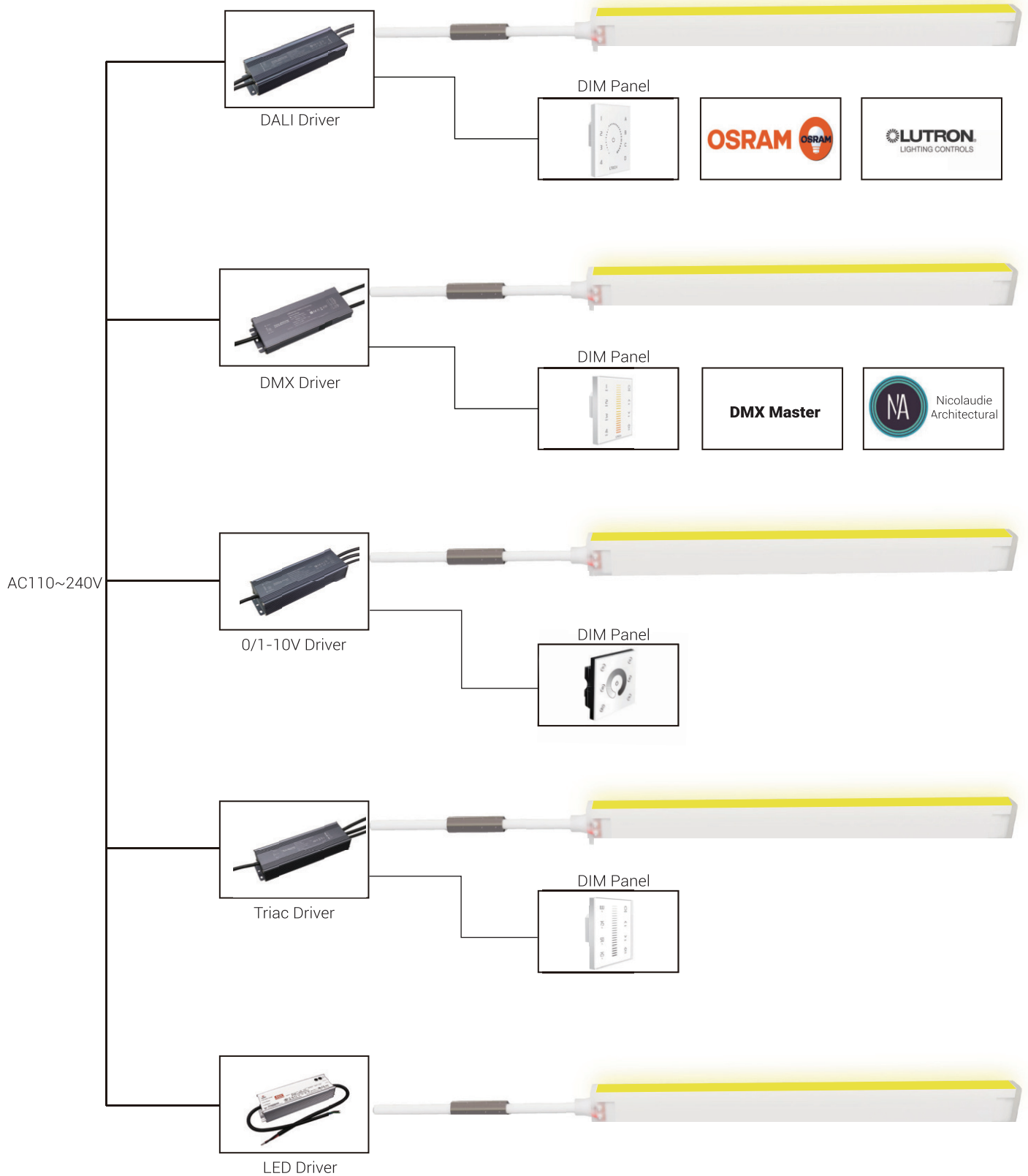

# LFX NEON SERIES 08 SPEC SHEET

LFX-N-08 -MONO 48V



## ORDERING CODE

PRODUCT	TYPE	MODEL	BENDING	POWER	VOLTAGE	CRI	COLOR	CONTROL
LFX	N - Neon	08 - 08	HB - Horizontal Bending	10 - 10W	DC - 48 VDC	80 - 80 CRI 90 - 90 CRI	CT 22 - 2200K CT 27 - 2700K CT 30 - 3000K CT 35 - 3500K CT 40 - 4000K CT 45 - 4500K CT 50 - 5000K CT 65 - 6500K GR - Green BL - Blue LY - Lemon Yellow PI - Pink	SW - Switch DALI - DALI DMX - DMX DIM - 0/1-10V TRI - TRIAC

Sample: LFX-N-08-HB-10-DC-80-CT22-SW

## PHOTOMETRIC DATA

### Illuminance Distribution

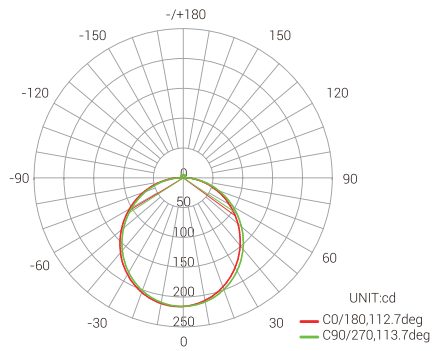

AVERAGE BEAM ANGLE(50%):113.2DEG

### Illuminance-Distance Curve

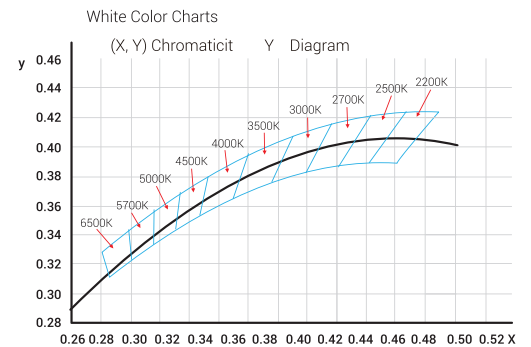
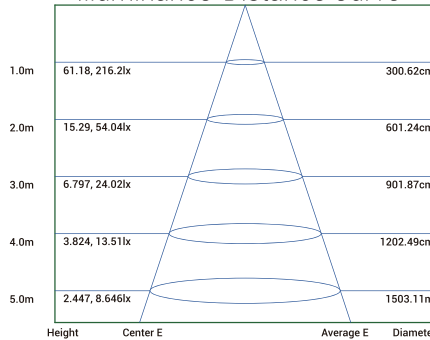

## ACCESSORIES

### MOLD INJECTION CONNECTOR (IP68 Factory Assembly Only)

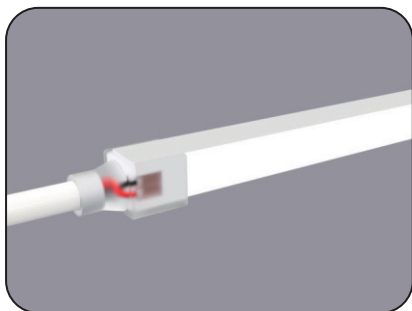

Direct Entry Connector  
 MJ-LFX08-A-D01/02/03  
 MJ-LFX08-A-D01SM  
 MJ-LFX08-A-D02SF  
 MJ-LFX08-A-D03SFM

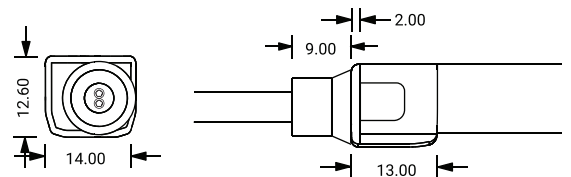

Side Entry Connector  
 MJ-LFX08-A-S01/02/03  
 MJ-LFX08-A-S01SM  
 MJ-LFX08-A-S02SF  
 MJ-LFX08-A-S03SFM

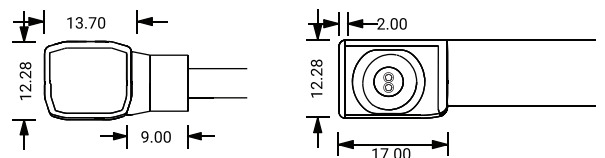

# LFX NEON SERIES 08 SPEC SHEET

LFX-N-08 -MONO 48V

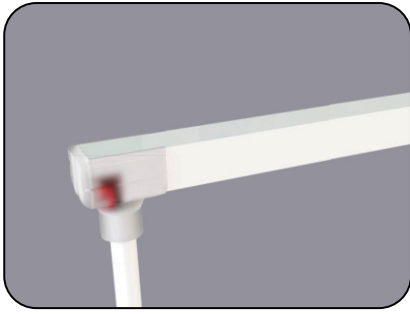

Bottom Entry Connector  
MJ-LFX08-A-B01/02/03  
MJ-LFX08-A-B01SM  
MJ-LFX08-A-B02SF  
MJ-LFX08-A-B03SFM

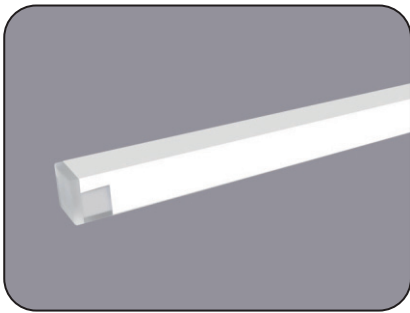
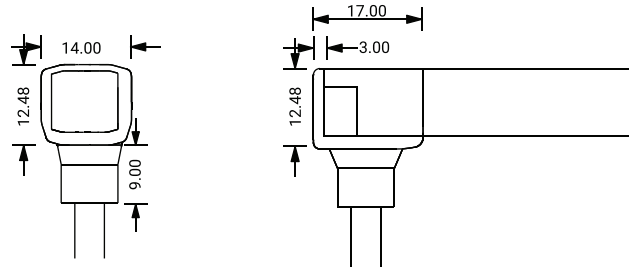

End Cap

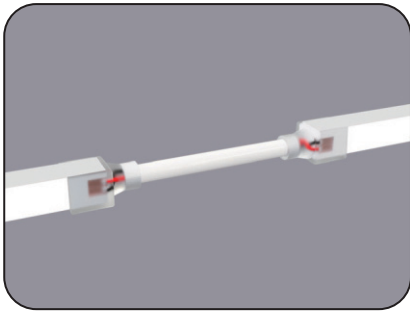
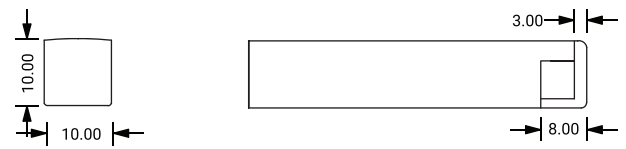

Jumper  
MJ-LFX06-A-D-JC

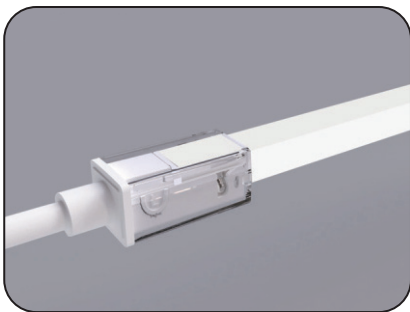
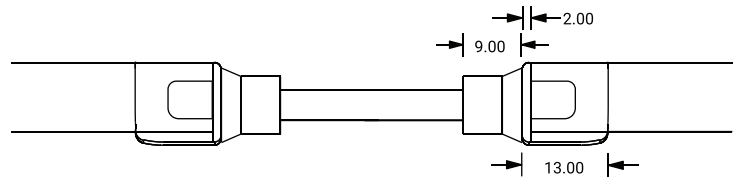

DIY Snap Connector  
DIY-SN-FR-08-D-01/02-A

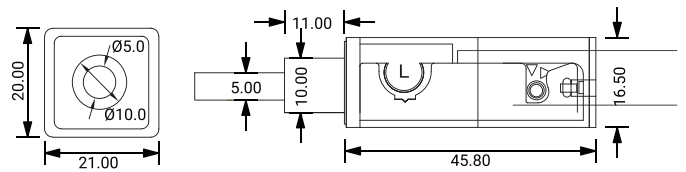

DIY Snap End Cap  
DIY-SN-END-08-D-01/02

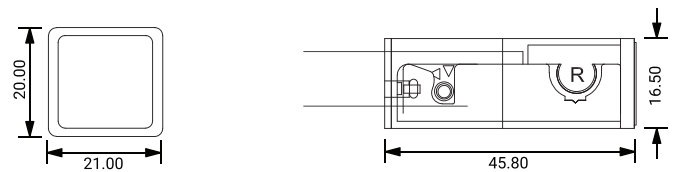

# LFX NEON SERIES 08 SPEC SHEET

LFX-N-08 -MONO 48V

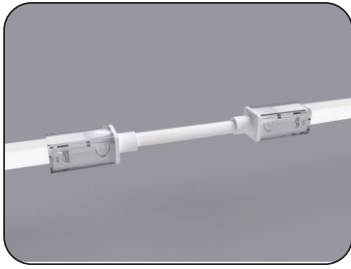

DIY Snap Extent Connector  
DIY-SN-EXT-08-A

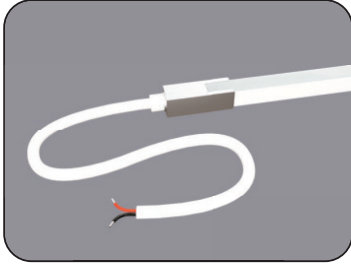
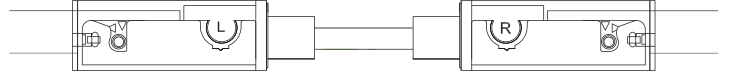

DIY Quick Connective Connector  
DIY-QC-FR-08-D-01/02-A

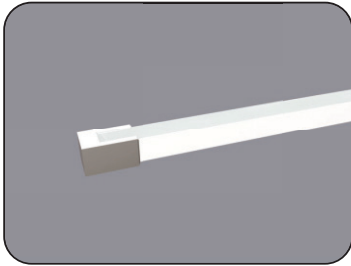
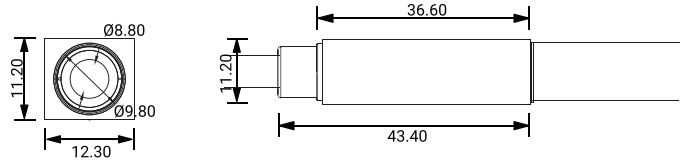

DIY Quick Connective End Cap  
DIY-QC-END-08

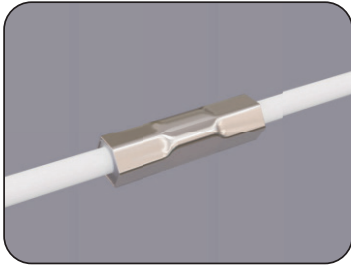
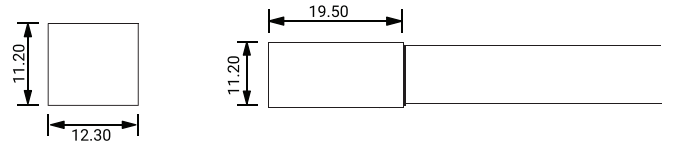

Waterproof Interrupter

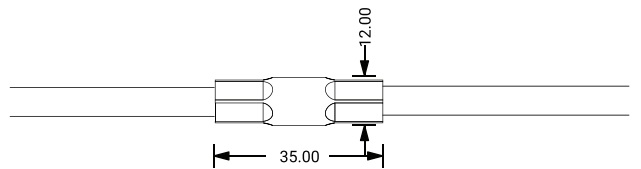

Male Connector  
M12-M-2C-18AWG-D6-W-0327-S

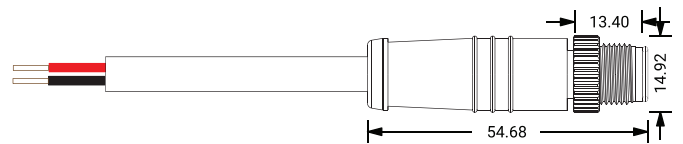

Female Connector  
M12-F-2C-18AWG-D6-W-0327-S

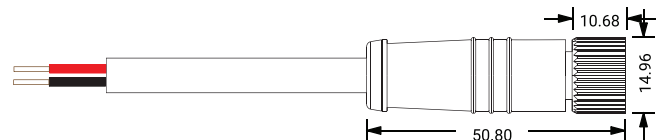

# LFX NEON SERIES 08 SPEC SHEET

LFX-N-08 -MONO 48V



## ALUMINUM CHANNEL



Dimension

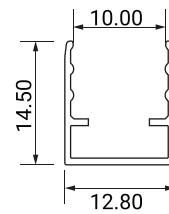

Installation Way

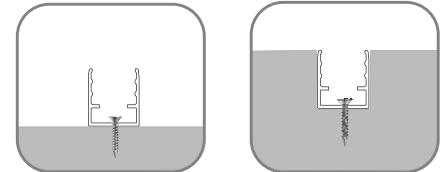

Surface Mounted

Recessed

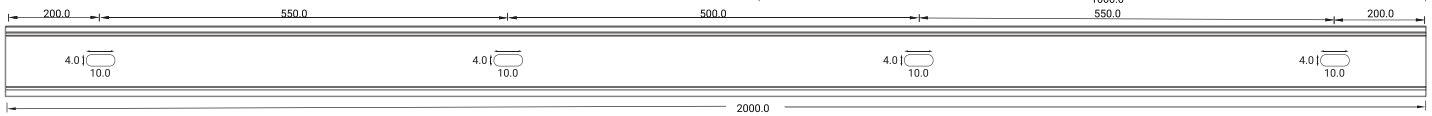
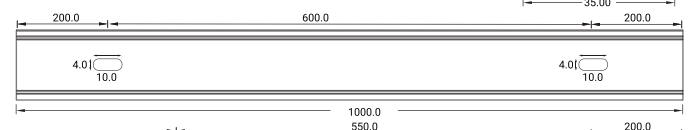
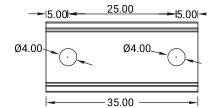

Model	W x H (mm)	Standard Length	Screw Holes	Holes Numbers
ALC08S01-035	12.80 x 14.50	35mm	Ø4.00mm	2
ALC08S01-100		1000mm	4.00mm	2
ALC08S01-200		2000mm	4.00mm	4



Dimension

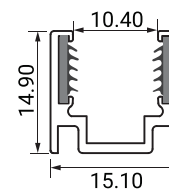

Installation Way

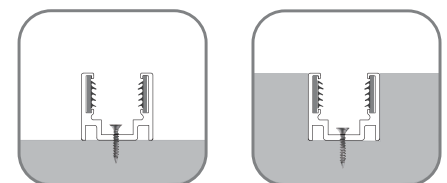

Surface Mounted

Recessed

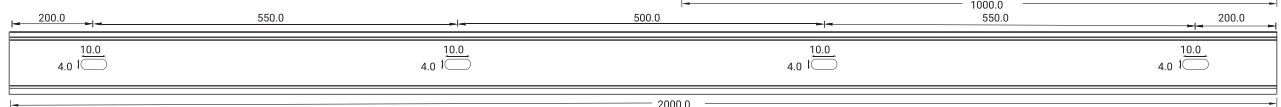
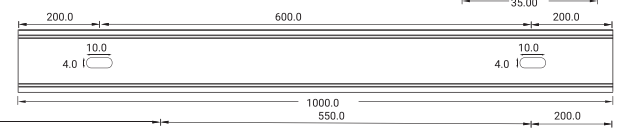
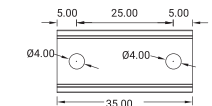

Model	W x H (mm)	Standard Length	Screw Holes	Holes Numbers
ALC08S02-035	15.10 x 14.90	35mm	Ø4.00mm	2
ALC08S02-100		1000mm	4.00mm	2
ALC08S02-200		2000mm	4.00mm	4

# LFX NEON SERIES 08 SPEC SHEET

LFX-N-08 -MONO 48V

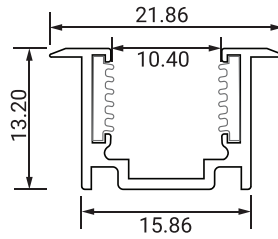
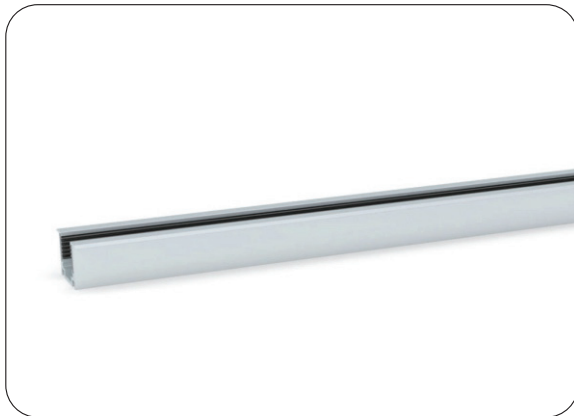

Installation Way

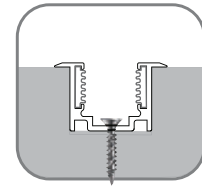

Recessed

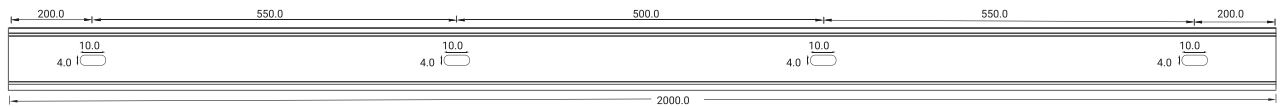
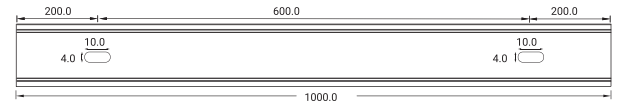
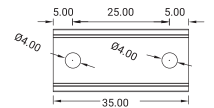

Model	W x H (mm)	Standard Length	Screw Holes	Holes Numbers
ALC08S03-035	21.86 x 13.20	35mm	Ø4.00mm	2
ALC08S03-100		1000mm	4.00mm	2
ALC08S03-200		2000mm	4.00mm	4



Dimension

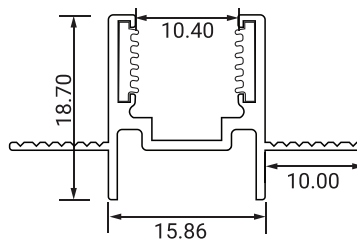

Installation Way

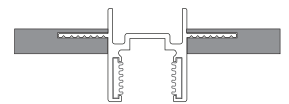

Ceiling Recessed

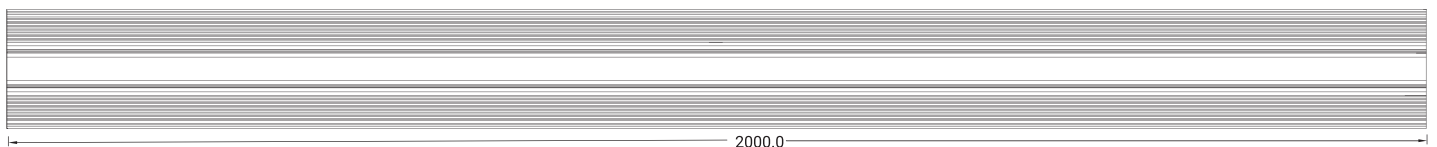
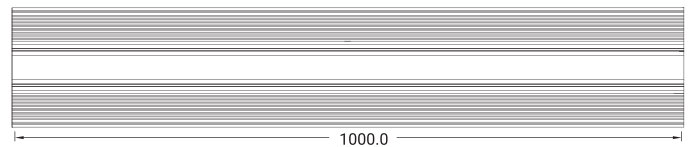

Model	W x H (mm)	Standard Length	Screw Holes	Holes Numbers
ALC08S04-035	35.86 x 18.70	35mm	Ø4.00mm	2
ALC08S03-100		1000mm	4.00mm	2
ALC08S03-200		2000mm	4.00mm	4

# LFX NEON SERIES 08 SPEC SHEET

LFX-N-08 -MONO 48V

## FLEXIBLE ALUMINUM CHANNEL

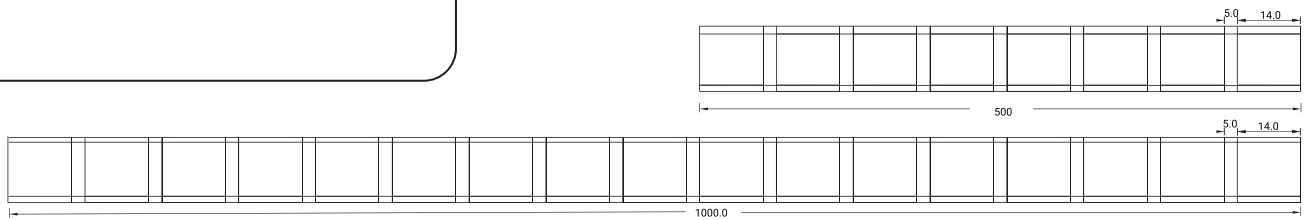
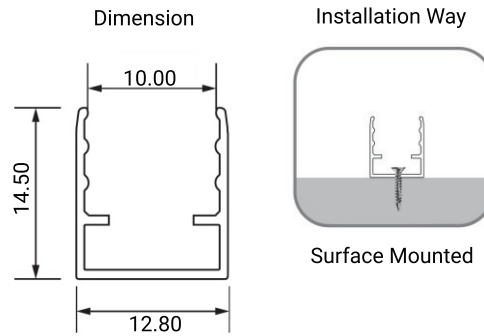
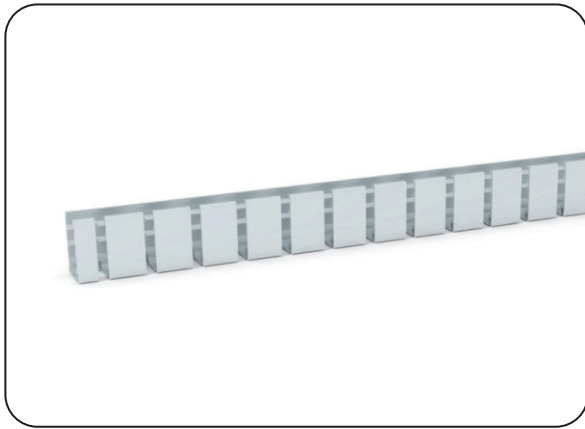

Model	W x H (mm)	Standard Length
ALC06S01FLX05	12.80 x 14.50	500mm
ALC06S01FLX10		1000mm
ALC06S01FLX20		2000mm

## STAINLESS STEEL CHANNEL

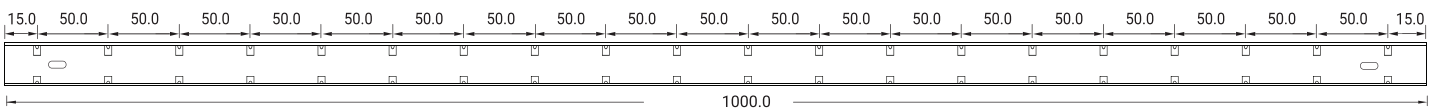
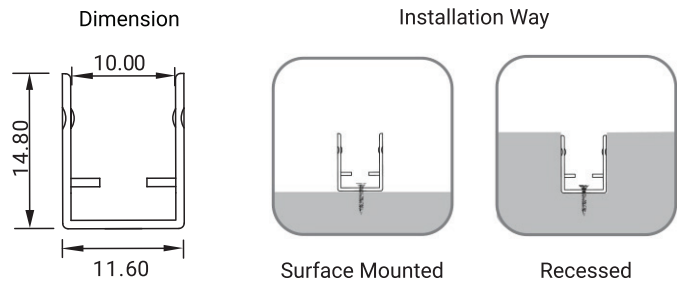

Model	W x H (mm)	Standard Length	Screw Holes	Holes Numbers
SSC06/08S01-100	11.60 x 14.80	1000mm	∅4.0 x 10mm	2



# LFX NEON SERIES 08 SPEC SHEET

LFX-N-08 -MONO 48V



## PLASTIC CHANNEL

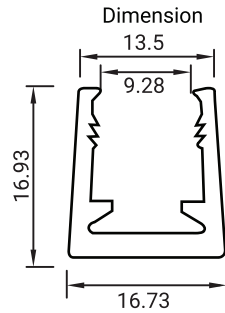
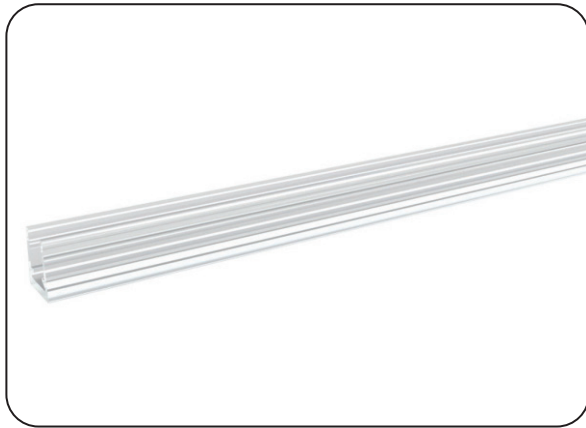

### Installation Way

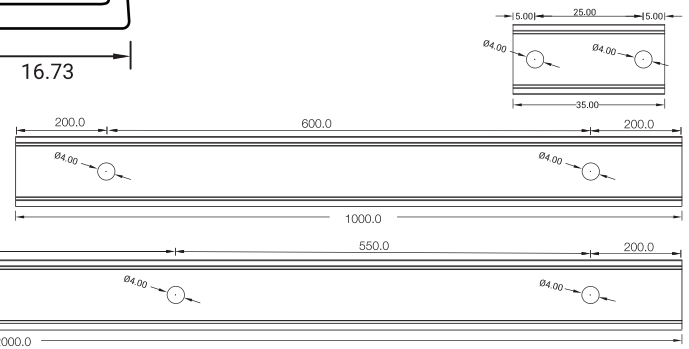
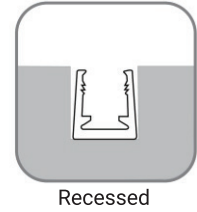
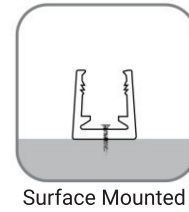

Model	W x H (mm)	Standard Length	Screw Holes	Holes Numbers
PC06S01-T	16.73 x 16.93	35mm	Ø4.00mm	2
		1000mm	Ø4.00mm	2
		2000mm	Ø4.00mm	4

## CEILING MOUNTED CHANNEL

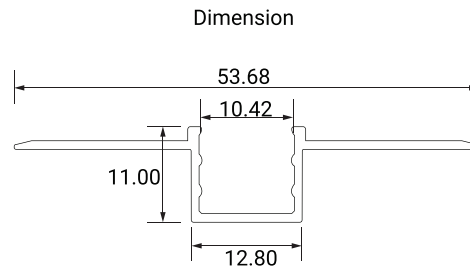
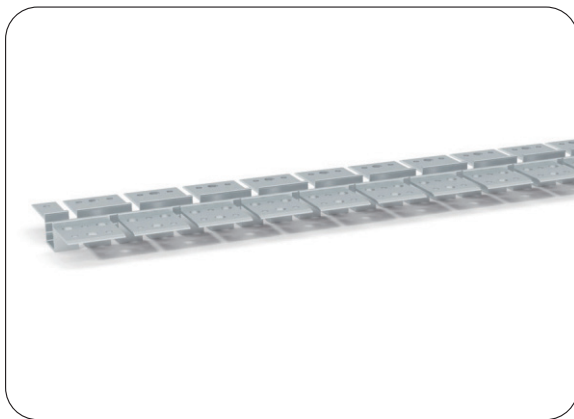

### Installation Way

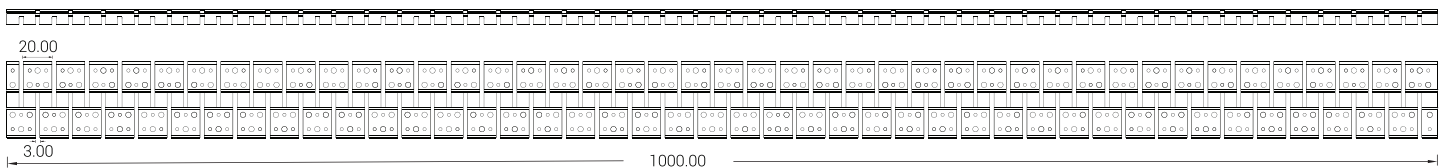

Model	W x H (mm)	Standard Length
ALC08S06FLX-100	15.10 x 24.40	500mm
ALC08S06FLX-200		1000mm