

LINEAR FIXTURE TRACK - MULTI-SPOT LINEAR PENDANT SPEC SHEET



LFT40-LC



The LFT40-LC is a multi-spot linear pendant fixture with a sleek-elongated profile designed for atmospheric lumination. With its wide range of track mounting options, the LFT40-LC is compatible with recessed, surface and suspended pendant mounting. It is equipped with dimming and standard color temperature of 3000K. The LFT40-LC has a rated power of 30 Watts.

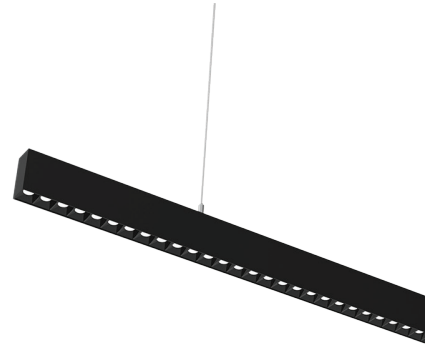

SPECIFICATIONS

OPERATING VOLTAGE	120 VAC
RATED POWER	30W
CONTROL	0/1-10 V Dimmable
FLUX	2112 lm
CRI	>90
BODY FINISH	Black, White
MOUNTING	Track mounted
PROJECTION	45°

V 120 VAC
Operating Voltage

W 30W
Rated Power

DIMENSIONS

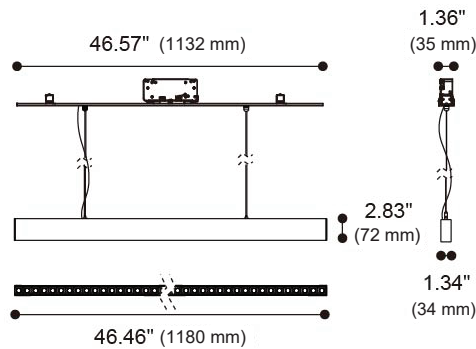

ORDERING CODE

SERIES	TYPE	POWER	VOLTAGE	CRI	COLOR TEMPERATURE	PROJECTION	TRACK MOUNTING	BODY FINISH
LFT40	LC - Multi-Spot Light	30W - 30 WATTS	AC - 120VAC	90 - CRI90	CT30 - 3000K CTXX - CUSTOM	45D - 45 Degrees	RM - Recessed Mount SM - Surface Mount PM - Pendant Mount	BK - Black WH - White

Sample: LFT40-LC - 30W - AC - 90 - CT30 - 45D - SM - BK

LINEAR FIXTURE TRACK - MOUNTING & ACCESSORIES

LFT40-LC

MOUNTING SPECIFICATIONS

TRIMLESS: LFT-T-01

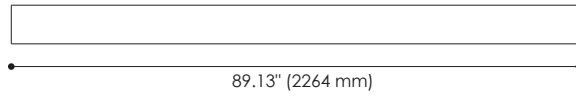
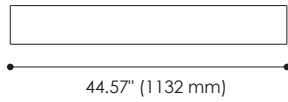
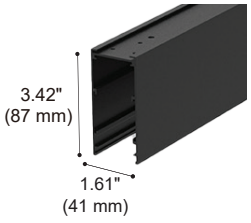

TRIMLESS TRACK SECTION	
Article number	TYPE
LFT-T-01-44	Channel
LFT-T-01-89	Channel

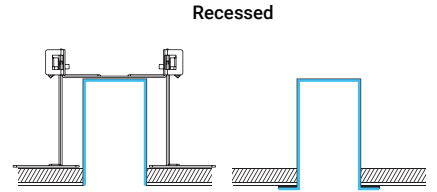

TRIM: LFT-F-01

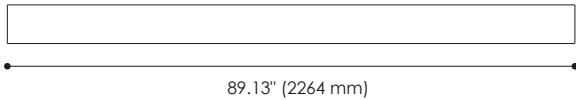
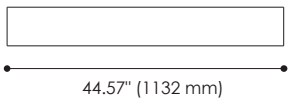
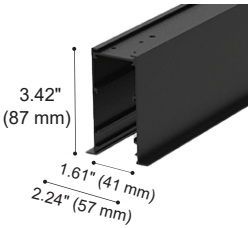

TRIMMED TRACK SECTION	
Article number	TYPE
LFT-F-01-44	Channel
LFT-F-01-89	Channel

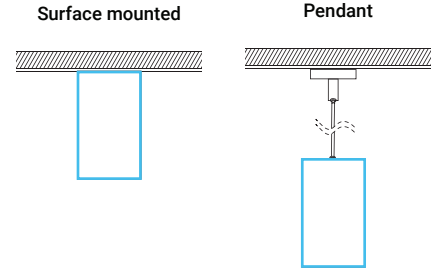

ACCESSORIES

ALL MODELS

3PCS
SKU: LFT-NC-02
Type: Surface mounted & Pendant reinforced plate

SKU: LFT-NC-06
Type: Light Leak-proof aluminum extrusion reinforce plate

Colours
● Black ○ White
SKU:
LFT-NE-01-11 11.14"(283 mm)
LFT-NE-01-22 22.28"(566 mm)
Type: Blank cover

SKU: LFT-SA-41
Type: Power cord connector

SKU: LFT-PA-41-180
71" (1800 mm)
Type: Power cord connect to AC

SKU: LFT-SA-41-30 12" (300 mm)
LFT-SA-41-60 24" (600 mm)
Type: Power cord connect between modules

SKU: LFT-PSA-31-180 71" (1800 mm)
Type: Signal wire connect to system / dimmer

SKU: LFT-SSA-31-30 12" (300 mm)
LFT-SSA-31-60 24" (600 mm)
Type: Signal wire connect between modules

PENDANT

SKU: LFT-DI-15
Type: Pendant Kit for power connection (without power cord)

SKU: LFT-DI-15-V
Type: Pendant Kit for power connection (without power cord and single wire)

SKU: LFT-DI-16
Type: Pendant kit

TRIM

2PCS
SKU: LFT-NC-04
Type: Trim end cap

TRIMLESS

2PCS
SKU: LFT-NC-01
Type: End cap

2PCS
SKU: LFT-NR-02
Type: Trimless bracket