

# LINEAR FIXTURE TRACK - MULTI-SPOT LINEAR PENDANT SPEC SHEET



LFT60-LC



The LFT60-LC is a multi-spot linear pendant fixture with a long profile designed large area lumination. With its wide range of track mounting options, the LFT60-LC is compatible with recessed, surface and suspended pendant mounting. It is equipped with dimming and standard color temperature of 3000K. The LFT60-LC has a rated power of 30 Watts.

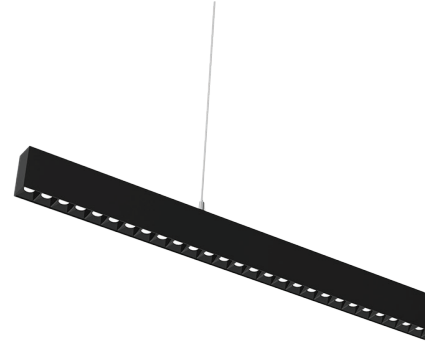

## SPECIFICATIONS

<b>OPERATING VOLTAGE</b>	120 VAC
<b>RATED POWER</b>	30W
<b>CONTROL</b>	0/1-10 V Dimmable
<b>FLUX</b>	2113 lm
<b>CRI</b>	>90
<b>BODY FINISH</b>	Black, White
<b>MOUNTING</b>	Track mounted
<b>PROJECTION</b>	45°

**V** 120 VAC  
Operating Voltage

**W** 30W  
Rated Power

## DIMENSIONS

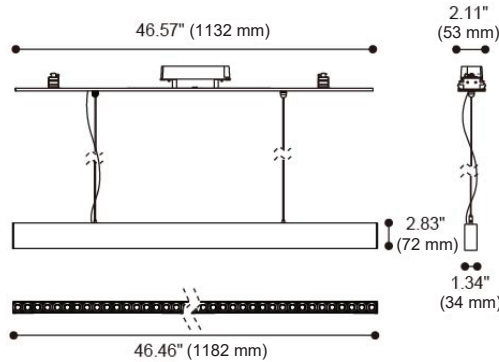

## ORDERING CODE

SERIES	TYPE	POWER	VOLTAGE	CRI	COLOR TEMPERATURE	PROJECTION	TRACK MOUNTING	BODY FINISH
LFT60	LC - Multi-Spot Light	30W - 30 WATTS	AC - 120VAC	90 - CRI90	CT30 - 3000K CTXX - CUSTOM	45D - 45 Degrees	RM - Recessed Mount SM - Surface Mount PM - Pendant Mount	BK - Black WH - White

Sample: LFT 60-LC - 30W - AC - 90 - CT30 - 45D - SM - BK

# LINEAR FIXTURE TRACK - MOUNTING & ACCESSORIES

LFT60-LC

## MOUNTING OPTIONS

### TRIMLESS: LFT-T-11

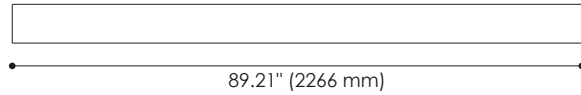
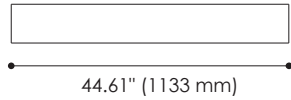
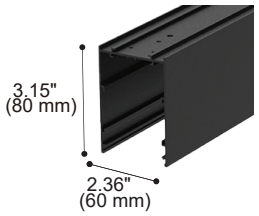

TRIMLESS TRACK SECTION	
Article number	TYPE
LFT-T-11-44	Channel
LFT-T-11-89	Channel

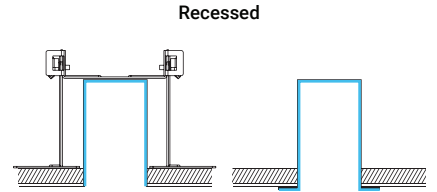

### TRIM: LFT-F-11

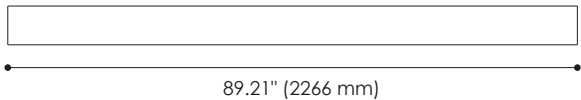
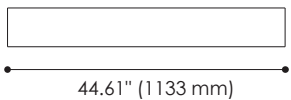
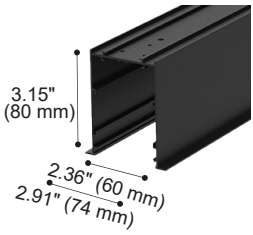

TRIMMED TRACK SECTION	
Article number	TYPE
LFT-F-11-44	Channel
LFT-F-11-89	Channel

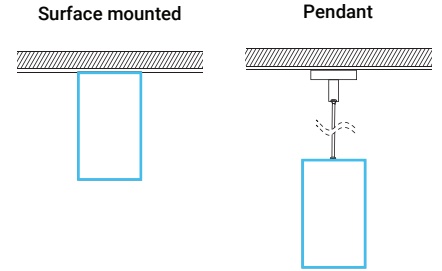

## ACCESSORIES

### ALL MODELS

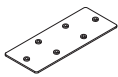
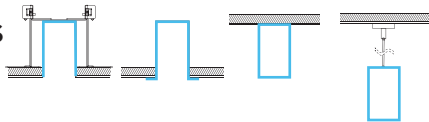

3PCS

SKU : LFT-NC-02  
Type : Surface mounted & Pendant reinforced plate

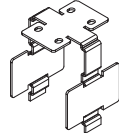

SKU : LFT-NC-07  
Type : Light Leak-proof aluminium extrusion reinforce plate



Colours  
Black White

SKU :  
LFT-NE-02-11 11.14" (283 mm)  
LFT-NE-02-22 22.28" (566 mm)  
Type : Blank cover



SKU : LFT-SA-41  
Type : Power cord connector



SKU : LFT-PA-41-180  
71" (1800 mm)  
Type : Power cord connect to AC



SKU : LFT-SA-41-30 12" (300 mm)  
LFT-SA-41-60 24" (600 mm)  
Type : Power cord connect between modules

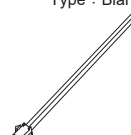

SKU : LFT-PSA-31-180 71" (1800 mm)  
Type : Signal wire connect to system / dimmer

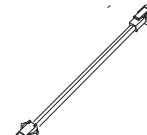

SKU : LFT-SSA-31-30 12" (300 mm)  
LFT-SSA-31-60 24" (600 mm)  
Type : Signal wire connect between modules

### PENDANT

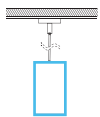

SKU : LFT-DI-15  
Type : Pendant Kit for power connection (without power cord)

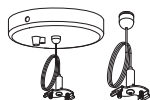

SKU : LFT-DI-15-V  
Type : Pendant Kit for power connection (without power cord and single wire)



SKU : LFT-DI-16  
Type : Pendant kit

### TRIM

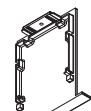
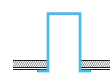

2PCS

SKU : LFT-NC-05  
Type : Trim end cap

### TRIMLESS

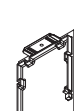
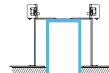

2PCS

SKU : LFT-NC-03  
Type : End cap

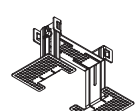

2PCS

SKU : LFT-NR-01  
Type : Trimless bracket