

# LINEAR FIXTURE TRACK - RECESSED SPOT SPEC SHEET



LFT60-G



The LFT60-G recessed downlight fixture is ideal for various lighting applications in both residential and commercial spaces. With its wide range of track mounting options, the LFT60-G is compatible with recessed, surface and suspended pendant mounting. It is equipped with dimming and standard color temperature of 3000K. The LFT60-G has a rated power of 15 Watts with three beam angle options, suitable for different environments.

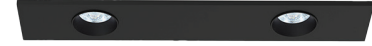

## SPECIFICATIONS

<b>OPERATING VOLTAGE</b>	120 VAC
<b>RATED POWER</b>	15W
<b>CONTROL</b>	0/1-10 V Dimmable
<b>FLUX</b>	792 lm
<b>CRI</b>	>90
<b>BODY FINISH</b>	Black, White
<b>BAFFLE FINISH</b>	Black, White
<b>MOUNTING</b>	Track mounted
<b>PROJECTION</b>	18°, 25°, 35°

**V** 120 VAC  
Operating Voltage

**W** 15W  
Rated Power

## DIMENSIONS

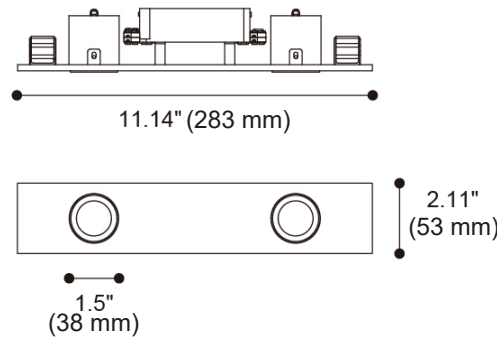

## ORDERING CODE

SERIES	TYPE	POWER	VOLTAGE	CRI	COLOR TEMPERATURE	PROJECTION	TRACK MOUNTING	BODY FINISH	BAFFLE FINISH
LFT60	G - Recessed Spot	15W - 15 WATTS	AC -120VAC	90 - CRI90	CT30 - 3000K CTXX - CUSTOM	18D - 18 Degrees 25D - 25 Degrees 35D - 35 Degrees	RM - Recessed Mount SM - Surface Mount PM - Pendant Mount	BK - Black WH - White	BK - Black WH - White

Sample: LFT 60-G - 15W - AC - 90 - CT30 - 35D - SM - BK

## PHOTOMETRIC DATA

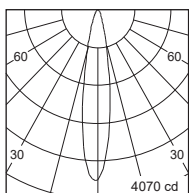

**BEAM ANGLE:** 18°  
**MAX. I:** 4070 cd.  
**FLUX:** 792 lm  
**SC (0-180):** .36  
**SC (90-290):** .30

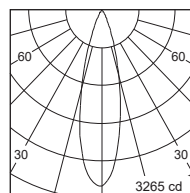

**BEAM ANGLE:** 25°  
**MAX. I:** 3265 cd.  
**FLUX:** 893 lm  
**SC (0-180):** .40  
**SC (90-290):** .42

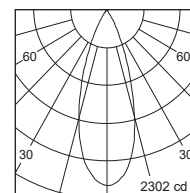

**BEAM ANGLE:** 35°  
**MAX. I:** 2302 cd.  
**FLUX:** 948 lm  
**SC (0-180):** .60  
**SC (90-290):** .58

# LINEAR FIXTURE TRACK - MOUNTING & ACCESSORIES

LFT60-G

## MOUNTING OPTIONS

### TRIMLESS: LFT-T-11

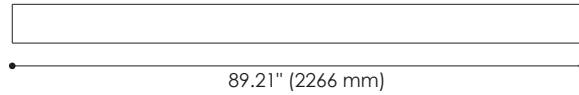
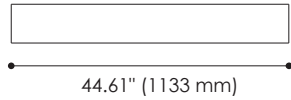
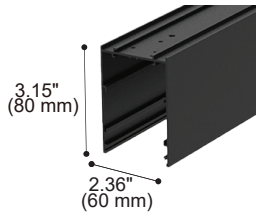

TRIMLESS TRACK SECTION	
Article number	TYPE
LFT-T-11-44	Channel
LFT-T-11-89	Channel

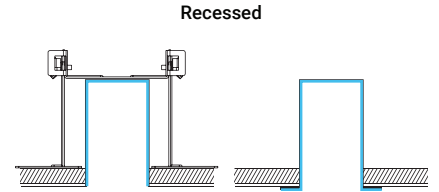

### TRIM: LFT-F-11

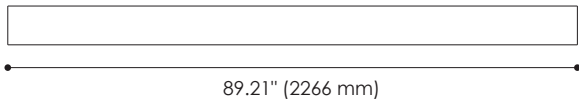
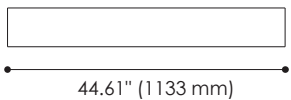
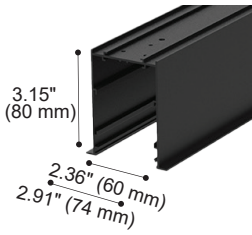

TRIMMED TRACK SECTION	
Article number	TYPE
LFT-F-11-44	Channel
LFT-F-11-89	Channel

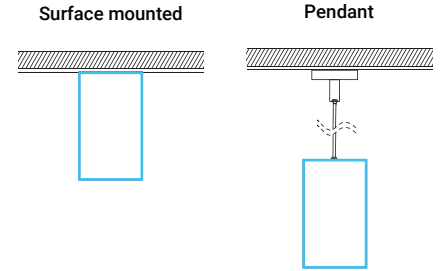

## ACCESSORIES

### ALL MODELS

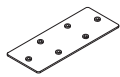
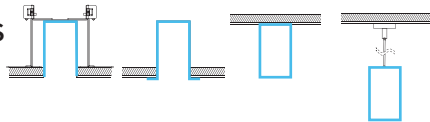

3PCS

SKU : LFT-NC-02  
Type : Surface mounted & Pendant reinforced plate

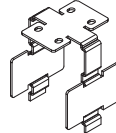

SKU : LFT-NC-07  
Type : Light Leak-proof aluminium extrusion reinforce plate



Colours  
Black White

SKU : LFT-NE-02-11 11.14\" (283 mm)  
LFT-NE-02-22 22.28\" (566 mm)  
Type : Blank cover



SKU : LFT-SA-41  
Type : Power cord connector



SKU : LFT-PA-41-180 71\" (1800 mm)  
Type : Power cord connect to AC

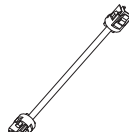

SKU : LFT-SA-41-30 12\" (300 mm)  
LFT-SA-41-60 24\" (600 mm)  
Type : Power cord connect between modules

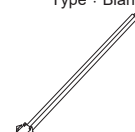

SKU : LFT-PSA-31-180 71\" (1800 mm)  
Type : Signal wire connect to system / dimmer

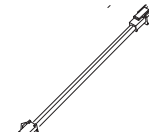

SKU : LFT-SSA-31-30 12\" (300 mm)  
LFT-SSA-31-60 24\" (600 mm)  
Type : Signal wire connect between modules

### PENDANT

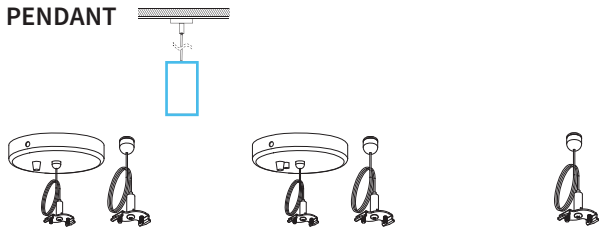

SKU : LFT-DI-15  
Type : Pendant Kit for power connection (without power cord)

SKU : LFT-DI-15-V  
Type : Pendant Kit for power connection (without power cord and single wire)

SKU : LFT-DI-16  
Type : Pendant kit

### TRIM

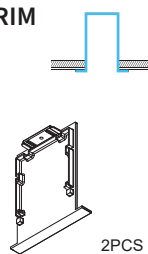

2PCS

SKU : LFT-NC-05  
Type : Trim end cap

### TRIMLESS

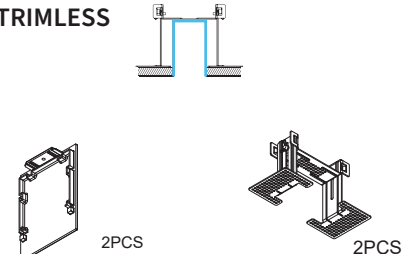

2PCS

SKU : LFT-NC-03  
Type : End cap

2PCS

SKU : LFT-NR-01  
Type : Trimless bracket