

# LINEAR FIXTURE TRACK - SPOT SPEC SHEET



LFT40-S



The LFT40-S Series is a range of spotlight solution ideal for ambient, focused or subject-specific lighting. With its wide range of track mounting options, the LFT40-S are compatible with recessed, surface and suspended pendant mounting. The series is equipped with dimming and standard color temperature of 3000K. With the versatility of 355-degree rotation and 90-degree tilt angle, the LFT40-S Series can direct its light to almost any direction. The LFT40-S2-2 in particular has two light engines with a power rating of 30 Watts and has three beam angles options.



LFT40-S2-2

## SPECIFICATIONS

OPERATING VOLTAGE	120 VAC
RATED POWER	30W
CONTROL	0/1-10 V Dimmable
FLUX	2376 lm
CRI	>90
BODY FINISH	Black, White
BAFFLE FINISH	Black, White, Copper
MOUNTING	Track mounted
PROJECTION	20°, 25°, 36°
ROTATION	355°
TILT ANGLE	90°

V	120 VAC Operating Voltage
W	30W Rated Power

## DIMENSIONS

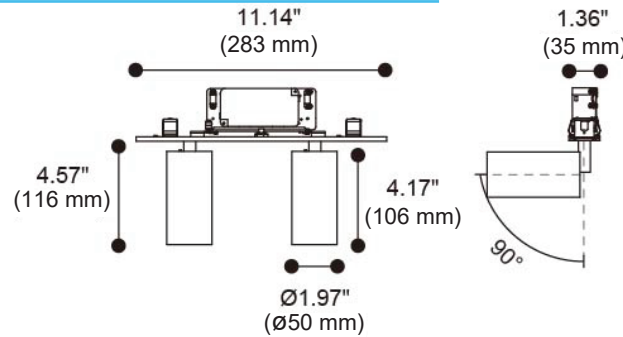

## ORDERING CODE

SERIES	TYPE	POWER	VOLTAGE	CRI	COLOR TEMPERATURE	PROJECTION	TRACK MOUNTING	BODY FINISH	BAFFLE FINISH
LFT40	S2-2 - Spot 2-2	30W - 30 WATTS	AC - 120VAC	90 - CRI90	CT30 - 3000K CTXX - CUSTOM	20D - 20 Degrees 25D - 25 Degrees 36D - 36 Degrees	RM - Recessed Mount SM - Surface Mount PM - Pendant Mount	BK - Black WH - White	BK - Black WH - White CO - Copper

Sample: LFT40-S2-2 - 30W- AC - 90 - CT30 - 20D - SM - BK - CO - ACHO-13

ACCESSORIES	
ACSN-11	Long Baffle
ACSG-9	Striped Glass
ACWG-10	Woven Glass
ACDS-8	Diffusion Sheet
ACHO-13	Honeycomb Louver

## PHOTOMETRIC DATA

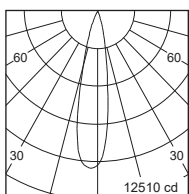

BEAM ANGLE: 20°  
MAX. I: 12510 cd.  
FLUX: 2376 lm

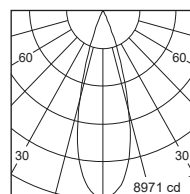

BEAM ANGLE: 30°  
MAX. I: 8971 cd.  
FLUX: 2376 lm

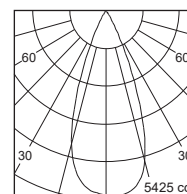

BEAM ANGLE: 40°  
MAX. I: 5425 cd.  
FLUX: 2376 lm

# LINEAR FIXTURE TRACK - MOUNTING & ACCESSORIES

LFT40-S

## MOUNTING SPECIFICATIONS

### TRIMLESS: LFT-T-01

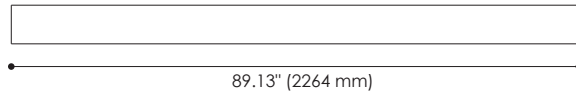
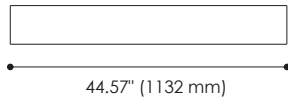
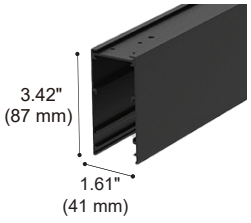

TRIMLESS TRACK SECTION	
Article number	TYPE
LFT-T-01-44	Channel
LFT-T-01-89	Channel

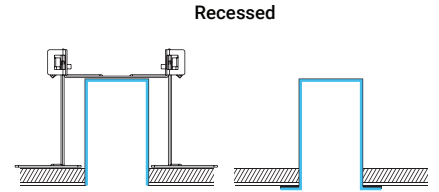

### TRIM: LFT-F-01

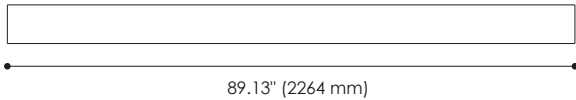
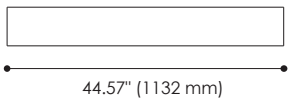
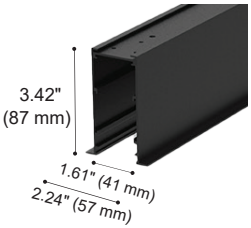

TRIMMED TRACK SECTION	
Article number	TYPE
LFT-F-01-44	Channel
LFT-F-01-89	Channel

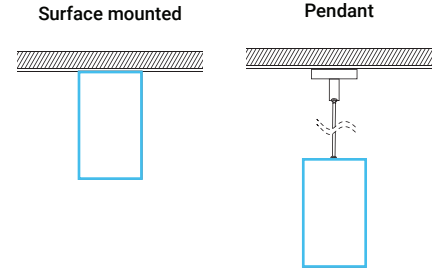

## ACCESSORIES

### ALL MODELS

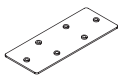
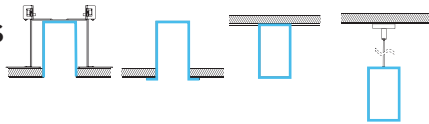

3PCS

SKU: LFT-NC-02  
Type: Surface mounted & Pendant reinforced plate

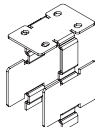

SKU: LFT-NC-06  
Type: Light Leak-proof aluminium extrusion reinforce plate



Colours  
● Black ○ White

SKU:  
LFT-NE-01-11 11.14"(283 mm)  
LFT-NE-01-22 22.28"(566 mm)  
Type: Blank cover



SKU: LFT-SA-41  
Type: Power cord connector



SKU: LFT-PA-41-180  
71" (1800 mm)  
Type: Power cord connect to AC



SKU: LFT-SA-41-30 12" (300 mm)  
LFT-SA-41-60 24" (600 mm)  
Type: Power cord connect between modules



SKU: LFT-PSA-31-180 71" (1800 mm)  
Type: Signal wire connect to system / dimmer



SKU: LFT-SSA-31-30 12" (300 mm)  
LFT-SSA-31-60 24" (600 mm)  
Type: Signal wire connect between modules

### PENDANT

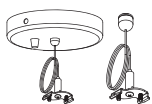
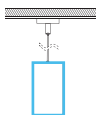

SKU: LFT-DI-15  
Type: Pendant Kit for power connection (without power cord)

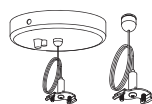

SKU: LFT-DI-15-V  
Type: Pendant Kit for power connection (without power cord and single wire)



SKU: LFT-DI-16  
Type: Pendant kit

### TRIM

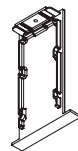
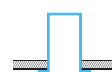

2PCS

SKU: LFT-NC-04  
Type: Trim end cap

### TRIMLESS

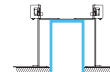

2PCS

SKU: LFT-NC-01  
Type: End cap

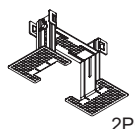

2PCS

SKU: LFT-NR-02  
Type: Trimless bracket