

LFX NEON SERIES

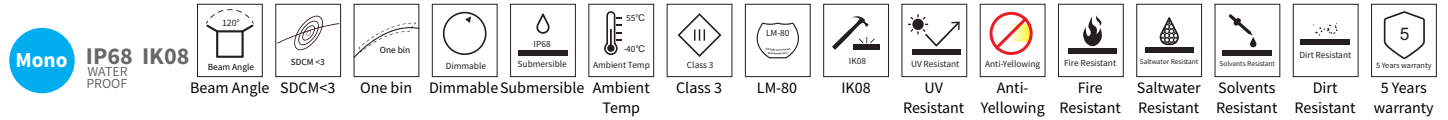

LFX-1717-VB (Vertical Bending Version)



YYZ LFX Neon series is designed to provide a very bright, crisp consistent and homogenized illumination that will accentuate any building, structure, or artistic flourish. Using high brightness surface mounted LEDs, behind a first-class eco-friendly UV-resistant Silicone polymer encapsulated flexible chamber material, the LFX Neon will provide your project with bright, consistent traces of light in shades of White, single colors. The fixture consists of uniform and even lighting with no Led hotspot. LFX Neon has a transverse minimum radius of 120mm and is vertical bendable. Easy to install, can be cut and reconnected with IP68 protected connector. The product is supplied in 5m standard rolls or custom as needed.

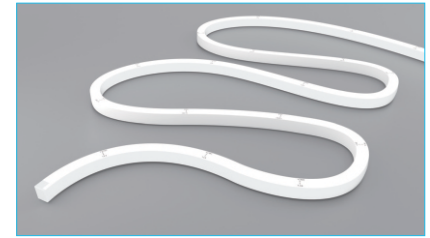

FEATURES

LIGHT SOURCE	LumiLEDs SMD LED 2835
WORKING VOLTAGE	DC 24V
RATED POWER	10W/m
LED QUANTITY	120 Leds / m
RADIANCE ANGLE	120°
LAMP LIFE	70,000 Hours L70@25°C 50,000 Hours L70@50°C
MOUNTING	Mounting clip / chanel
CONNECTION	Outdoor rated connections
CUTTING INCREMENTS	100mm (1 Unit, 12LEDs)
MINIMUM BEND DIAMETER	120mm
DIMENSIONS	16.5mm(W) x 16.5mm(H)
OPERATING TEMP	-40° C - +55° C
STORAGE TEMP	-20° C - +55° C
CONTINUOUS LENGTH	5mtr
DIMMING	Non dim, Dali
IP RATING	IP68 Wet location submersible <2m

- LUMILEDS LED Quality
- 24 V DC Working Voltage
- 10W/m Rated power

ELECTRICAL DATA

POWER CONSUMPTION	10W/m
SUPPLY VOLTAGE	DC 24 V
COLORS	2700K, 2800K, 3000K, 4000K, 5000K, 6000K
CRI	80, 90

ORDERING LOGIC

PRODUCT	POWER	COLOR TEMPEARATURE	CRI
LFX 1717-VB	10 - 10 W	(CT 27) - 2700K	80 - 80
		(CT 28) - 2800K	90 - 90
		(CT 30) - 3000K	
		(CT 40) - 4000K	
		(CT 50) - 5000K	
		(CT 60) - 6000K	

Sample: LFX 1717-VB - 10 - CT27 - 80

LUMEN CHART

White	Lumen Output
2700K (CT 27)	365lm/m
2800K (CT 28)	369lm/m
3000K (CT 30)	375lm/m
4000K (CT 40)	385lm/m
5000K (CT 50)	375lm/m
6000K (CT 60)	370lm/m

LFX NEON SERIES

LFX-1717-VB (Vertical Bending Version)

BENDING DETAILS

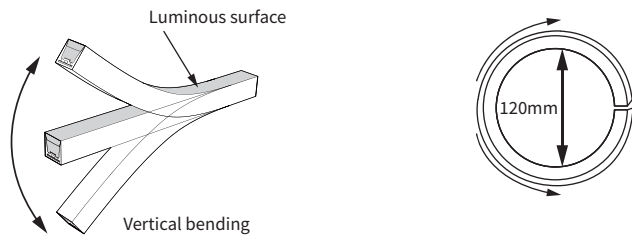

DIMENSION

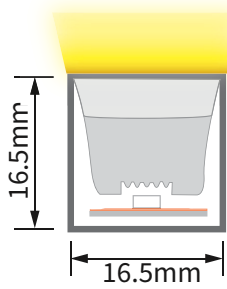

ACCESSORIES

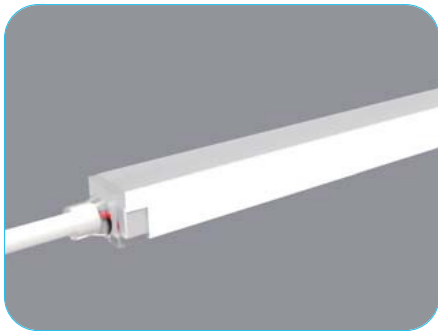

Direct Entry Connector
 YYZ-MIC-DEC-01 (Single Feed-Right Side)
 YYZ-MIC-DEC-02 (Single Feed-Left Side)
 YYZ-MIC-DEC-03 (Double Feed-Both Side)

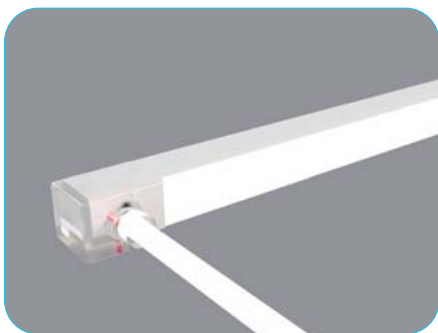
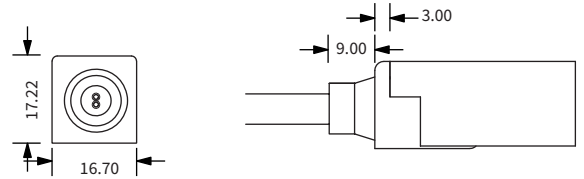

Side Entry Connector
 YYZ-MIC-SEC-01 (Single Feed-Right Side)
 YYZ-MIC-SEC-02 (Single Feed-Left Side)
 YYZ-MIC-SEC-03 (Double Feed-Both Side)

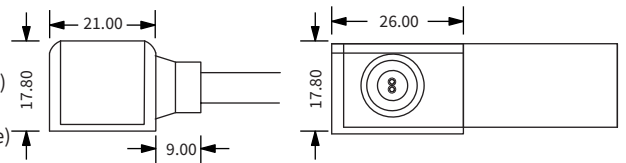

Bottom Entry Connector
 YYZ-MIC-BEC-01 (Single Feed-Right Side)
 YYZ-MIC-BEC-02 (Single Feed-Left Side)
 YYZ-MIC-BEC-03 (Double Feed-Both Side)

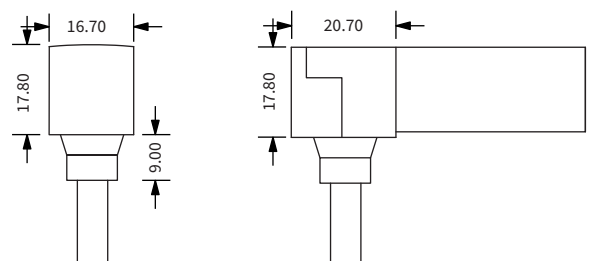

LFX NEON SERIES

LFX-1717-VB (Vertical Bending Version)

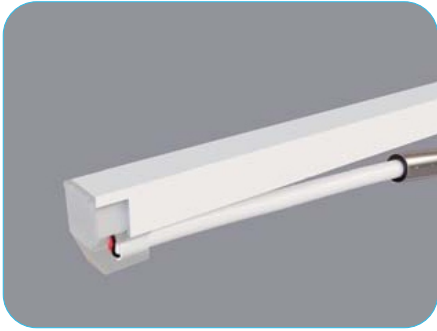

L Shape Entry Connector
 YYZ-MIC-LSEC-01 (Single Feed-Right Side)
 YYZ-MIC-LSEC-02 (Single Feed-Left Side)
 YYZ-MIC-LSEC-03 (Double Feed-Both Side)

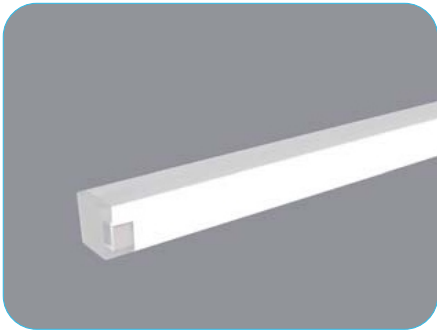
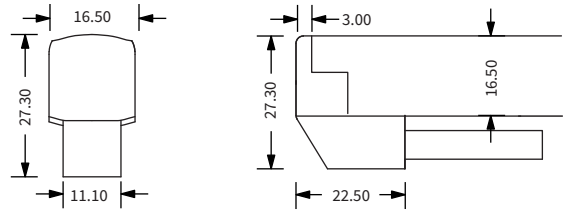

End Cap
 YYZ-EC

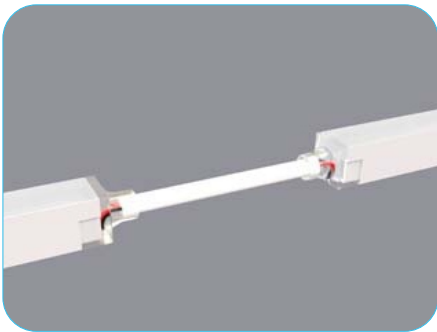
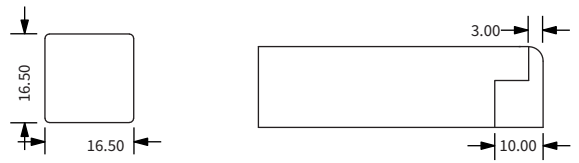

Jumper
 YYZ-JC

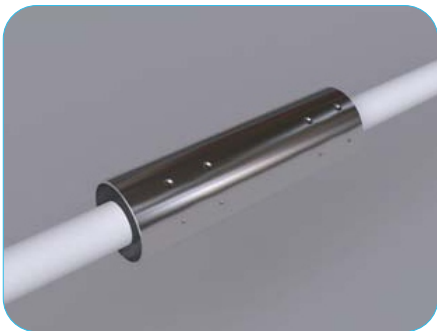
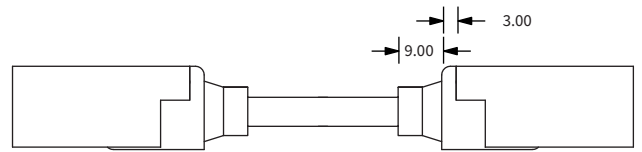

Waterproof Interrupter
 YYZ-WP-I

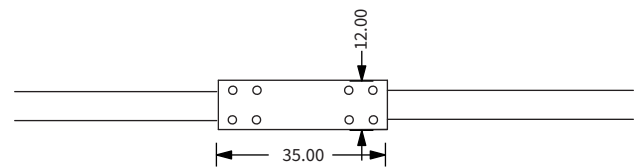

Male Connector
 YYZ-MC

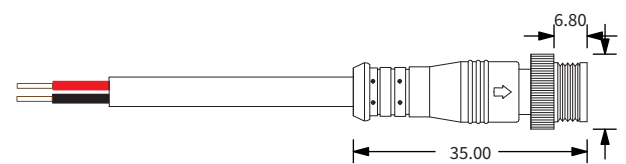

LFX NEON SERIES

LFX-1717-VB (Vertical Bending Version)

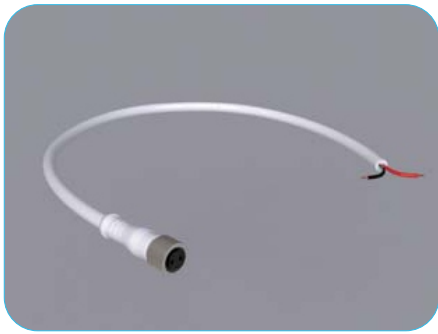

Female Connector
YYZ-FC

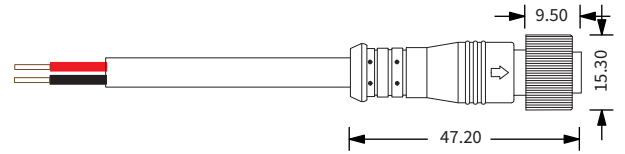

ALUMINIUM CHANNEL

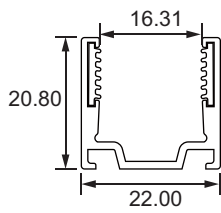

Installation Way

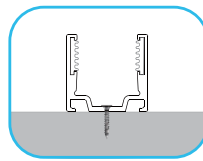

Surface Mounted

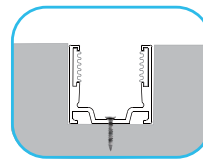

Recessed

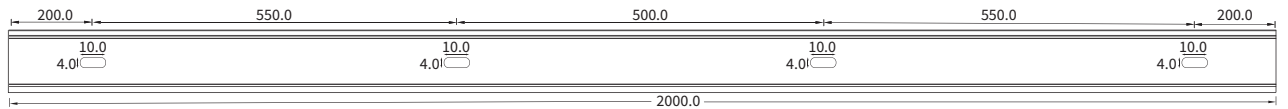
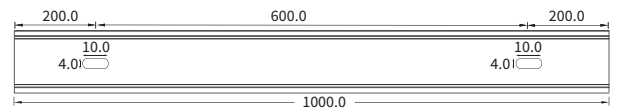
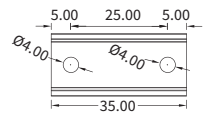

Model	W x H (mm)	Standard Length	Screw Holes	Holes Numbers
YYZ-AC-1-35-4-2-LFX-17-VB	22.00 x 20.80	35mm	Ø4.0mm	2
YYZ-AC-1-1000-4-2-LFX-17-VB		1000mm	4.0mm	2
YYZ-AC-1-2000-4-4-LFX-17-VB		2000mm	4.0mm	4

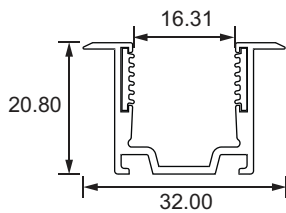

Installation Way

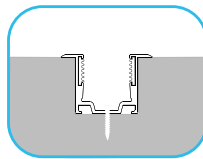

Recessed

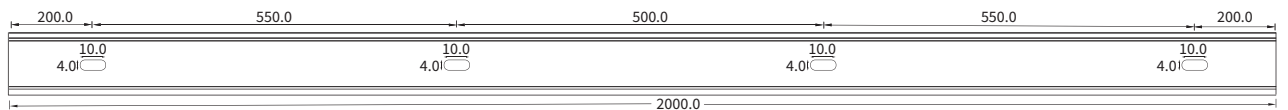
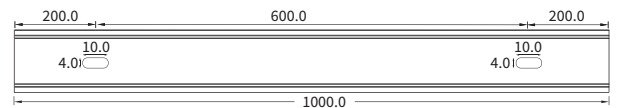
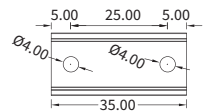

Model	W x H (mm)	Standard Length	Screw Holes	Holes Numbers
YYZ-AC-2-35-4-2-LFX-17-VB	22.00 x 22.80	35mm	Ø4.0mm	2
YYZ-AC-2-1000-4-2-LFX-17-VB		1000mm	4.0mm	2
YYZ-AC-2-2000-4-4-LFX-17-VB		2000mm	4.0mm	4

LFX NEON SERIES

LFX-1717-VB (Vertical Bending Version)

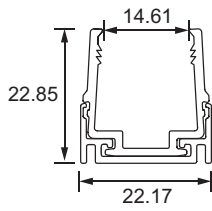
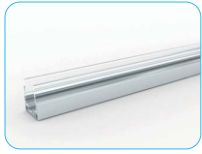

Installation Way

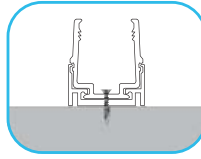

Surface Mounted

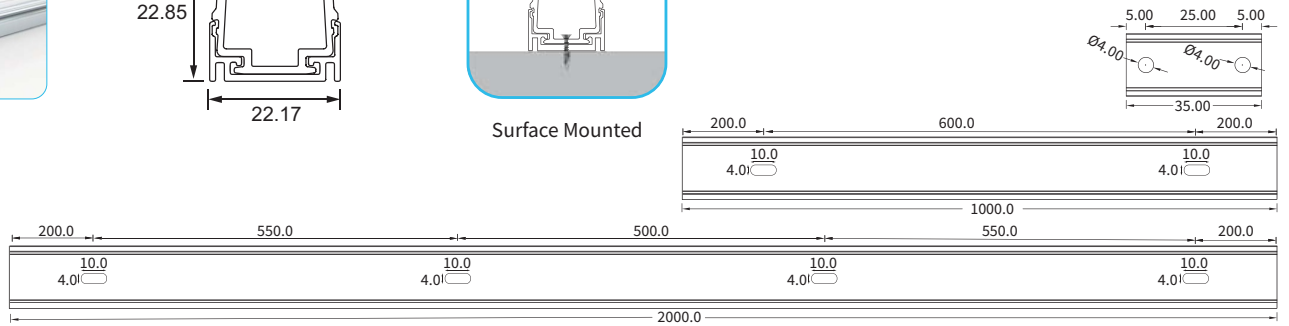

Model	W x H (mm)	Standard Length	Screw Holes	Holes Numbers
YYZ -AC-3-35-4-2-LFX-17-VB	22.17 x 22.85	35mm	Ø4.0mm	2
YYZ-AC-3-1000-4-2-LFX-17-VB		1000mm	4.0mm	2
YYZ-AC-3-2000-4-4-LFX-17-VB		2000mm	4.0mm	4

STAINLESS STEEL CHANNEL

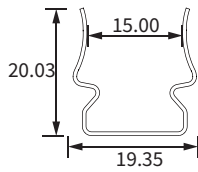
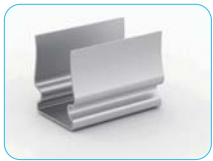

Installation Way

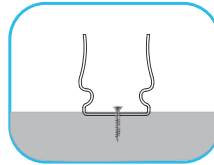

Surface Mounted

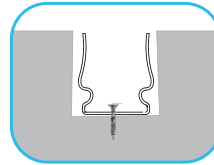

Recessed

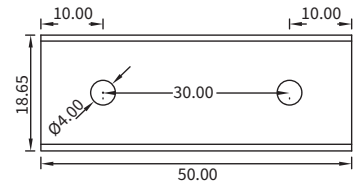

Model	W x H (mm)	Standard Length	Screw Holes	Holes Numbers
YYZ-SSC-50-4-2-LFX-17-VB	19.35 x 20.03	50mm	Ø4.0mm	2

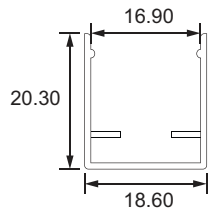

Installation Way

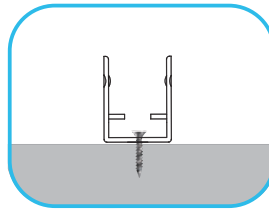

Surface Mounted

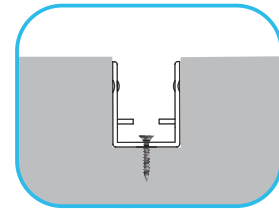

Recessed

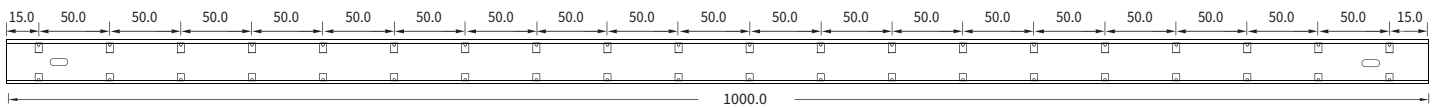

Model	W x H (mm)	Standard Length	Screw Holes	Holes Numbers
YYZ -SSC-1000-4x10-2-LFX-17-VB	18.60 x 20.30	1000mm	4.0 x 10mm	2

LFX NEON SERIES

LFX-1717-VB (Vertical Bending Version)

LINEAR FLEX CHANNEL

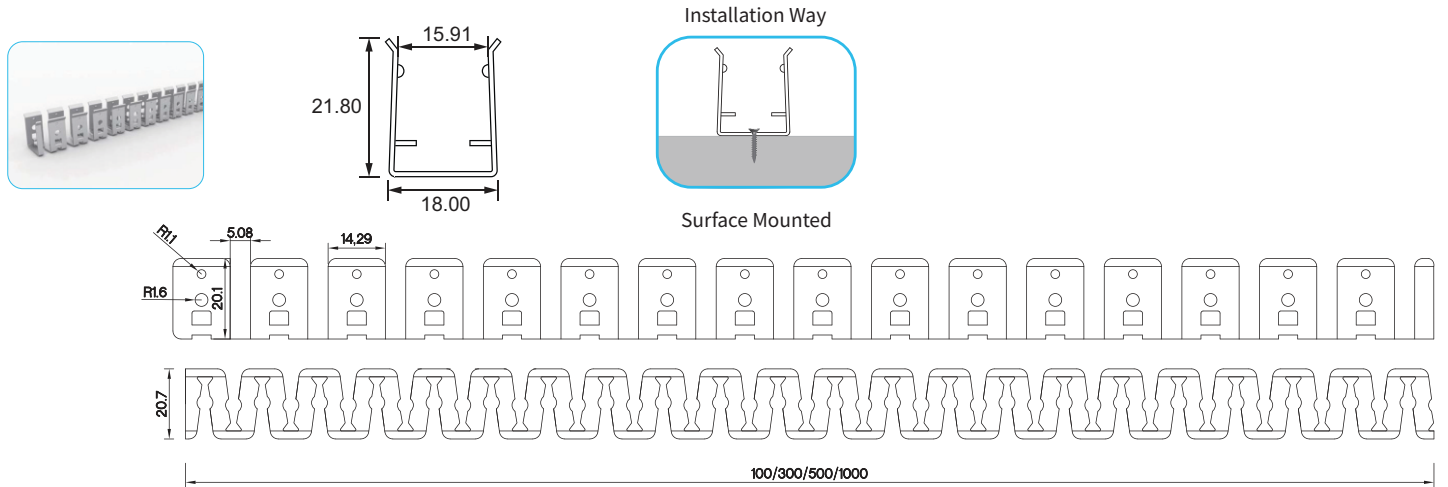

Model	W x H (mm)	Standard Length
YYZ -SSC-FLX-100-LFX-17-VB	18.00 x 21.80	100mm
YYZ -SSC-FLX-300-LFX-17-VB		300mm
YYZ -SSC-FLX-500-LFX-17-VB		500mm
YYZ -SSC-FLX-1000-LFX-17-VB		1000mm