

SAUNA LFX SPEC SHEET

LFX-S-9.6-CTXX-2835-Z3-120-24V-CV-H-1-HT-RMTLWL10

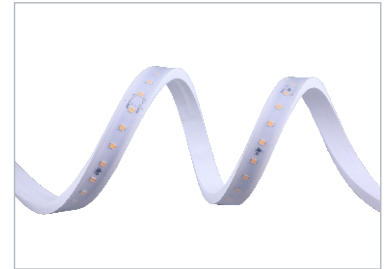

The LED Flex Strip for Sauna rooms is a high-quality lighting solution specifically designed to withstand the extreme heat conditions of sauna environments. With a rating for use in ambient temperatures up to 100 degrees Celsius, this flexible strip is built to endure the intense heat and humidity in saunas. The LED technology ensures efficient and long-lasting illumination, while the flexible design allows for easy installation and customization to fit any sauna room layout. The strip's heat-resistant construction and reliable performance make it an ideal choice for creating a soothing and visually appealing atmosphere in sauna rooms without compromising on safety or durability.



FEATURES

LIGHT SOURCE	2835 Led
LED QUANTITY	120 Leds / mtr
FINISH	White PCB
WORKING VOLTAGE	24 Volts
RATED POWER	9.6W / mtr
RADIANCE ANGLE	120°
LAMP LIFE	50,000 hrs
MOUNTING	Bracket, Channel
CONNECTION	Hardwired tails
CUTTING INCREMENTS	Every 50 mm/ 6 Leds
DIMENSIONS	16.5mm(W) x 7mm(H) x 10000mm(L)
MAX DAISY RUN	5 mtr
TYPICAL LUMENS	850lm/m
OPERATING AMBIENT TEMP	0-100°C

- 120 LEDs / mtr**
LED Quality
- 24VOLTS**
Working Voltage
- 9.6W / mtr**
Rated power

ELECTRICAL DATA

POWER CONSUMPTION	9.6W
SUPPLY VOLTAGE	24 Volts
COLORS	2700K / 3000K / 4000K
CRI	90
CONTROL	On/Off, DALI, 0-10V



Front connector



Endcap

DIMENSIONS

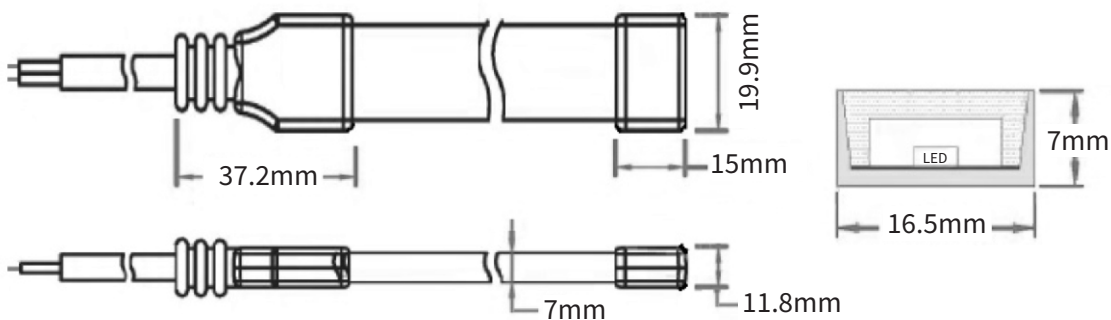

ORDERING LOGIC

PRODUCT SERIES	TYPE	POWER	COLOR TEMPERATURE	LED TYPE	BIN	NO. OF LED	VOLTAGE	CIRCUIT	CRI	NO OF LED ROWS	CONNECTION
LFX	S - Sauna (IP67)	9.6 - 9.6W	(CT27) 2700K (CT30) 3000K (CT40) 4000K	2835	Z3	120 - 120 LEDs/mtr	24-24V	CV-Constant voltage	H - HIGH (90)	1	HT - Hardwired Tail OC - Outdoor Connector

MODEL	COLOR CONTROL	LIGHT EMITTING DIRECTION	LED POWER	PCB COLOR	LENGTH PER REEL
R - Regular	M - Mono	T - Top	L - Low	W - White	L10 - 10mtr

Sample: LFX - S - 9.6 - CT XX - 2835 - Z3 - 120 - 24 - CV - H - 1 - HT - RMTLWL10