

# VERTEX FLEX-Y22E-VB/HB MONO-24V

## VTF Y22E

**Mono** IP67 IK08 C E

YYZ Vertex flex is designed to provide a very bright, crisp consistent and homogenized illumination that will accentuate any building, structure or artistic flourish. Using 96 high brightness surface mounted LEDs/meter, behind a first class eco-friendly UV-resistant PVC encapsulated flexible chamber material, it helps to provide bright, consistent traces of light in 10 shades of white, single colors of red, green and blue. The fixture consists of uniform and even lighting with no Led hotspot and has a transverse minimum diameter of 300mm. It is easy to be installed, can be cut and re connected with IP68 protected connector. Connectors at both ends offer ease of installation and is supplied in 5m standard rolls-or custom. Operating at 24V, the Vertex Flex features consistent brightness along the entire run, precise drive current, and long life expectancy. Dimming is achieved with YYZ's dimming compatible power supplies.



### FEATURES

LED QUANTITY	96 Leds / mtr
FINISH	PVC Encapsulated flexible chamber material
WORKING VOLTAGE	24 Volts
RATED POWER	9W/ mtr
RADIANCE ANGLE	120°
LAMP LIFE	50,000 hrs
MOUNTING	Mounting clip / Chanel
CONNECTION	Outdoor rated connections
CUTTING INCREMENTS	20.80mm (1 Unit/2 leds)
DIMENSIONS	17(H) x 16(W)
OPERATION TEMP	-20° C - +50° C
STORAGE TEMP	-20° C - +60° C
WEIGHT	0.325 kg/mtr
CONTINUOUS LENGTH	10mtr

CREE/OSRAM  
LED Quality

24 VOLTS  
Working Voltage

9W / mtr  
Rated power

### ELECTRICAL DATA

POWER CONSUMPTION	9W/ mtr
SUPPLY VOLTAGE	24 Volts
COLORS	2200K, 2500K, 2700K, 3000K, 3500K, 4000K, 5700K, 6000K
CRI	80+
LEDS / 3.3FT	96
LUMEN	46lm/m

### ORDERING LOGIC

PRODUCT	BENDING	COLOR TEMPERATURE	VOLTAGE	FIXTURE LENGTH	MOUNTING	CONNECTION	CUSTOM		
VTF Y22E	VB - Vertical	(CT 22)	2200K	24 (24 VDC)	10 - 10Mtr	CLP - Clip	OC - Outdoor Connector	xx	
		(CT 25)	2500K		(###) CUSTOM				
	HB - Horizontal	(CT 27)	2700K	24 (24 VDC)	10 - 10Mtr	CLP - Clip	OC - Outdoor Connector	xx	
		(CT 30)	3000K						
		(CT 35)	3500K						
		(CT 40)	4000K						
		(CT 57)	5700K						
		(CT 60)	6000K						
		(CT 27)	2700K						CHL - Chanel
		(CT 30)	3000K						

(Order Extrusion and End cap as per site requirement)

Sample: VTF Y22E - VB - CT 22 - 24 - 10 - CLP - OC - XX

## DIMENSION

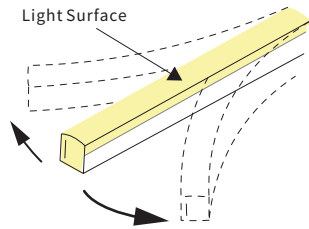

HORIZONTAL BENDING

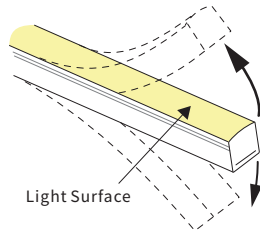

VERTICAL BENDING

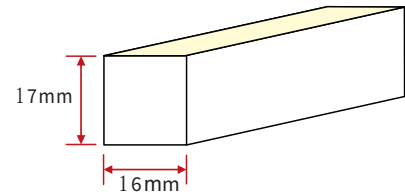

Note: Unless otherwise stated, the tolerance of the light is  $\pm 0.3\text{mm}$ .

## BENDING DETAILS

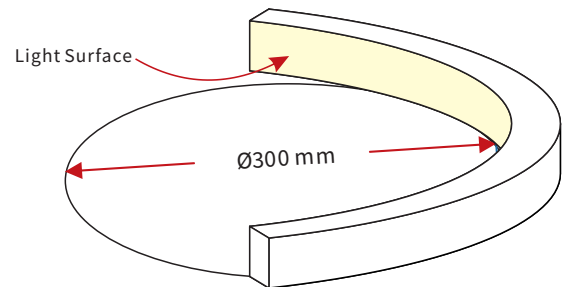
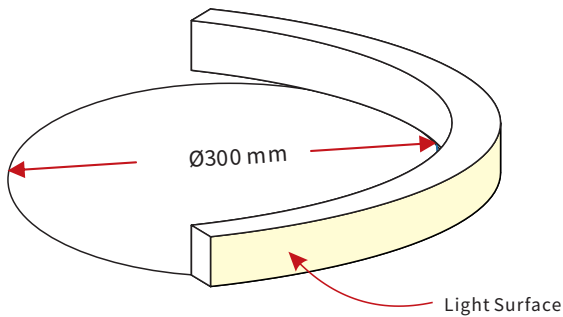

The light can only be bent along the light surface. Do not bend smaller than allowed minimum bend diameter.

## TYPES OF CONNECTOR

### INJECTION-MOULDED CONNECTOR

Note: Unless otherwise stated, the tolerance of the connector is  $\pm 0.5\text{mm}$ .



#### INJECTION-MOULDED FRONT CONNECTOR (BOTTOM)

Connects light to power supply with pre-installed bottom feed cable IP67. Available in 0.3m, 1m, 3m, 5m, 10m, 15m, 20m lengths.

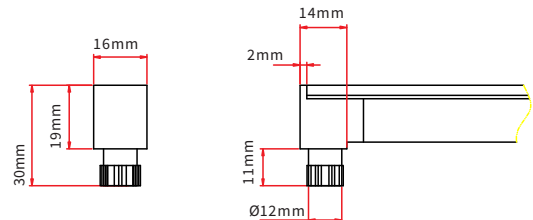

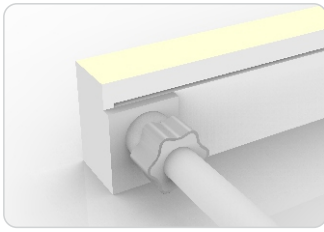

### INJECTION-MOULDED FRONT CONNECTOR (SIDE)

Connects light to power supply with pre-installed side feed cable, IP67. Cable length available in 0.3m, 1m, 3m, 5m, 10m, 15m, 20m.

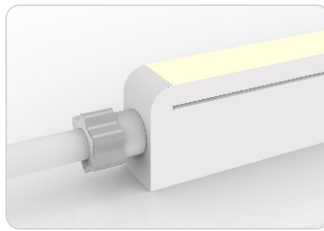
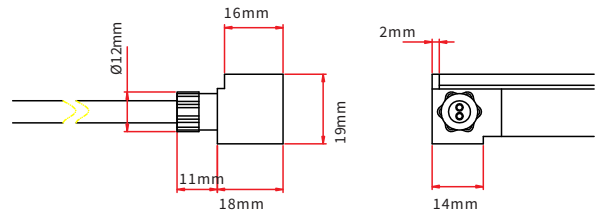

### INJECTION-MOULDED FRONT CONNECTOR (END)

Connects light to power supply with pre-installed end feed cable, IP67. Cable length available in 0.3m, 1m, 3m, 5m, 10m, 15m, 20m.

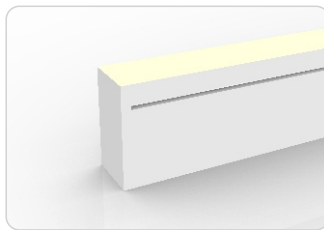
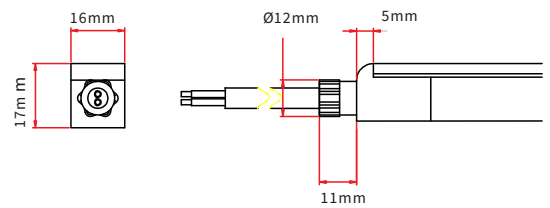

### INJECTION-MOULDED END CAP

Pre-installed termination protection of the light, IP67.

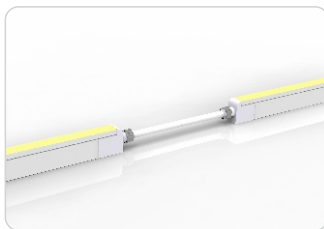
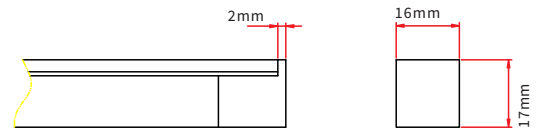

### INJECTION-MOULDED JUMPER

Connects two pieces of lights together with a flexible cable. IP67 Injection-moulded connector. L available in 0.3-1m.

Maximum 8 Jumpers in 20m  
Maximum 4 Jumpers in 10m

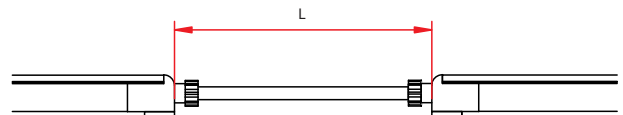

### INJECTION-MOULDED T-FEED

Connects two pieces of lights together with a T joint, energized from middle. IP67 Injection-moulded connector. L1 and L2 available in 0.15-0.5m. L3 available in 0.3-3m.

Maximum 8 T-feeds in 20m  
Maximum 4 T-feeds in 10m

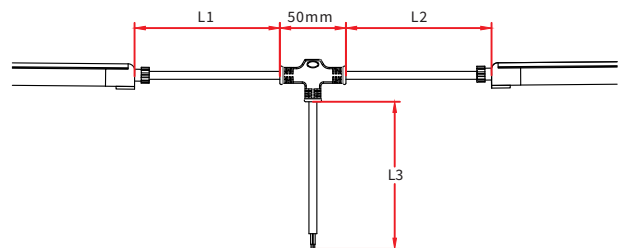

## DUAL INJECTION-MOULDED CONNECTOR

Note: Unless otherwise stated, the tolerance of the connector is ±0.5mm.

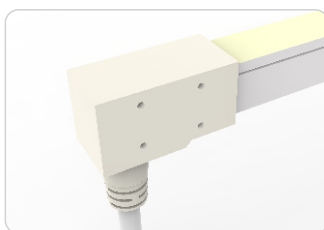

### DUAL INJECTION-MOULDED FRONT CONNECTOR (BOTTOM)

Connects light to power supply with pre-installed bottom feed cable, IP68. Cable length available in 0.3m, 1m, 3m, 5m, 10m, 15m, 20m.

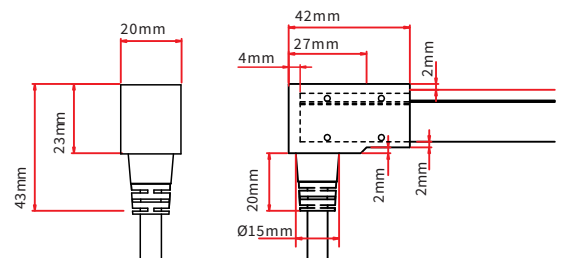

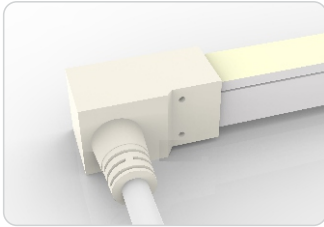

### DUAL INJECTION-MOULDED FRONT CONNECTOR (SIDE)

Connects light to power supply with pre-installed side feed cable, IP68. Cable length available in 0.3m, 1m, 3m, 5m, 10m, 15m, 20m.

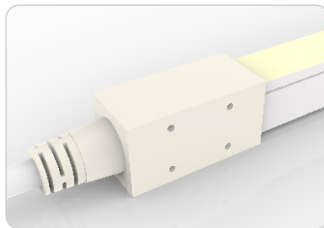
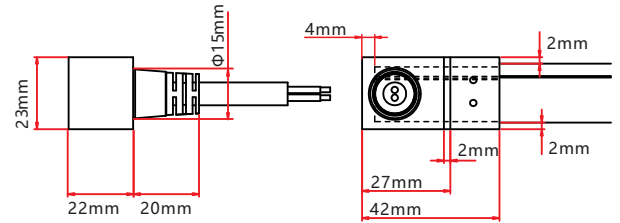

### DUAL INJECTION-MOULDED FRONT CONNECTOR (TOP END)

Connects light to power supply with pre-installed end feed cable, IP68. Cable length available in 0.3m, 1m, 3m, 5m, 10m, 15m, 20m.

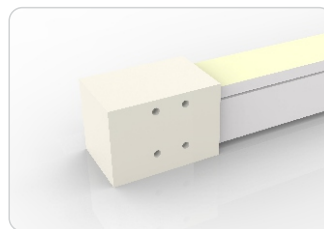
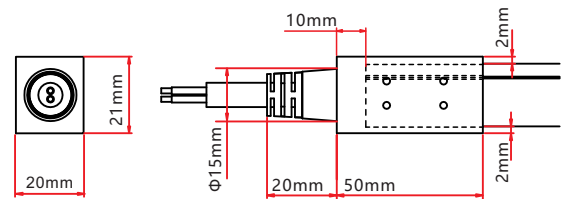

### DUAL INJECTION-MOULDED END CAP

Pre-installed termination protection of the light, IP68.

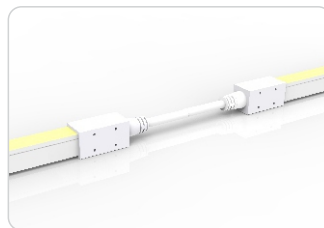
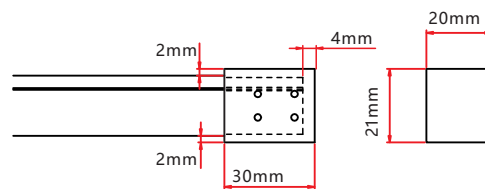

### DUAL INJECTION-MOULDED JUMPER

Connects two pieces of lights together with a flexible cable. IP68 Dual Injection-moulded connector. L available in 0.3~1m.

Maximum 8 Jumpers in 20m  
Maximum 4 Jumpers in 10m

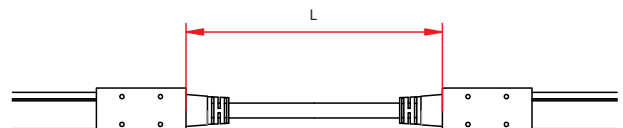

### DUAL INJECTION-MOULDED T-FEED

Connects two pieces of lights together with a T joint, energized from middle. IP68 Dual Injection-moulded connector. L1 and L2 available in 0.15~0.5m. L3 available in 0.3-3m.

Maximum 8 T-feeds in 20m  
Maximum 4 T-feeds in 10m

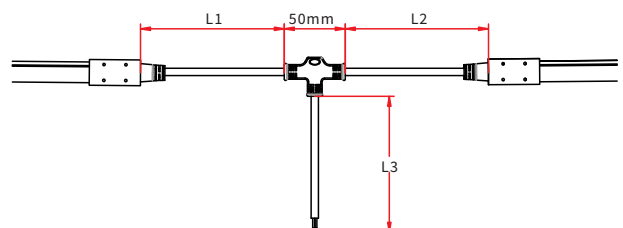

## ANTI-WICKING FERRULE

Note: Unless otherwise stated, the tolerance is  $\pm 0.5\text{mm}$ .

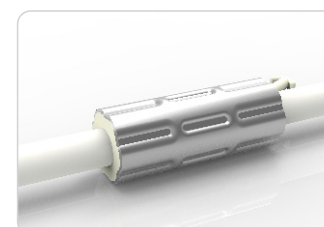

### ANTI-WICKING FERRULE

The anti-wicking ferrule is located at 115mm ( $\pm 5\text{mm}$  tolerance) from the connector on the cable.

For protection against water ingress from inside of cable wire and hence damage the light.

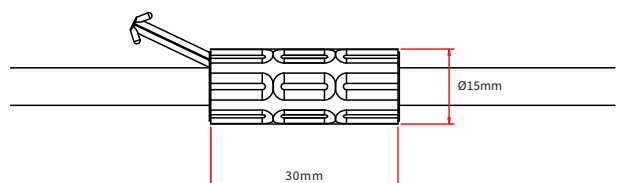

## MALE & FEMALE CONNECTOR

Note: Unless otherwise stated, the tolerance is  $\pm 2\text{mm}$ .



### MALE & FEMALE CONNECTOR

For plug and play cable junction, DIY or Pre-installed connector, IP68

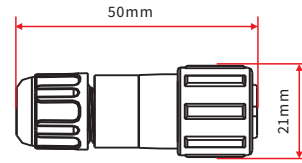

## MOUNTING PROFILE

### STANDARD ALUMINUM PROFILE

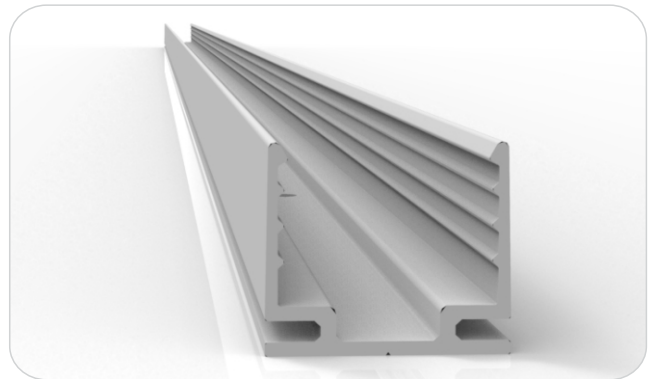
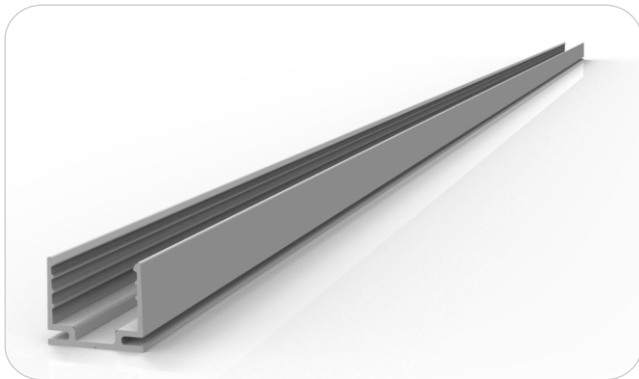

### DIMENSIONS

Note: Unless otherwise stated, the tolerance of the profile is  $\pm 0.5\text{mm}$ .

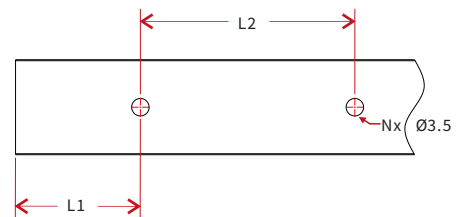
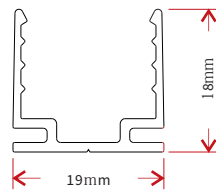
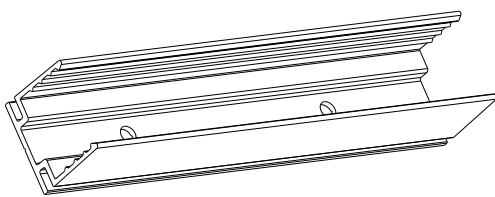

Model	W*H(mm)	Standard Length (mm)	L1 (mm)	L2 (mm)	Screw Hole (mm)	Hole Number	For Product
W22-A/PL	19*18	35	17.5	/	Ø3.5	1	W22
		500	50	200	Ø3.5	3	W22
		1000	100	200	Ø3.5	5	W22
		2000	100	200	Ø3.5	10	W22

## PLASTIC PROFILE

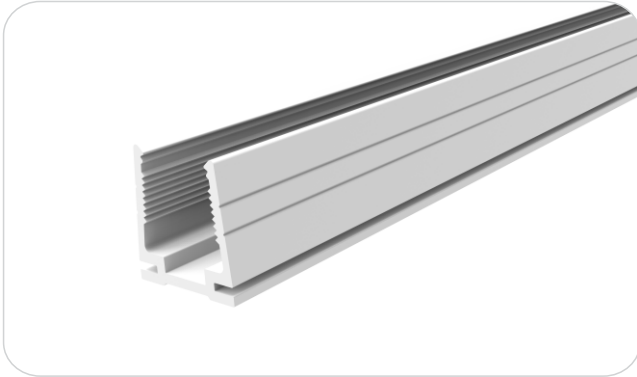

Note: Unless otherwise stated, the tolerance of the profile is  $\pm 0.5\text{mm}$ .

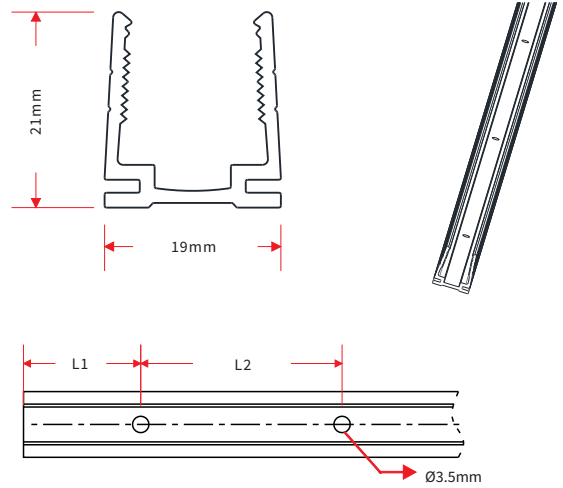

Model	W*H(mm)	Standard Length (mm)	L1 (mm)	L2 (mm)	Screw Hole (mm)	Hole Number	For Product
W22-PC/PL	19*21	500	50	200	Ø3.5	3	W22
		1000	100	200	Ø3.5	5	W22
		2000	100	200	Ø3.5	10	W22

## SELF-LOCKING ALUMINUM PROFILE (USING WITH THE CLIP)

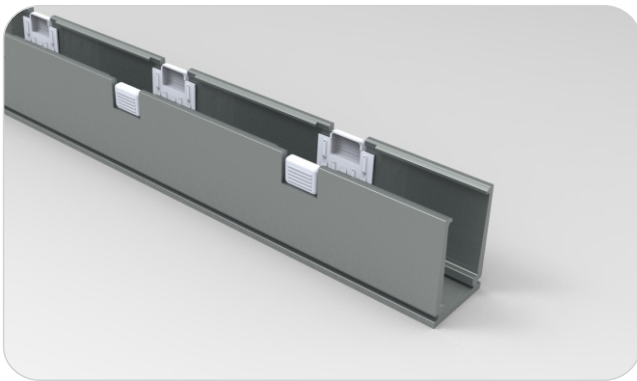

Note: Unless otherwise stated, the tolerance of the profile is  $\pm 0.5\text{mm}$ .

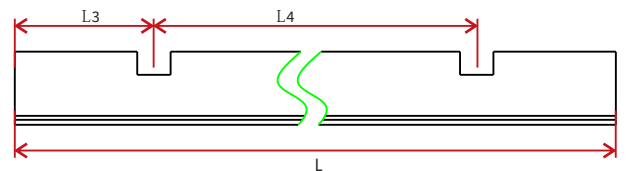
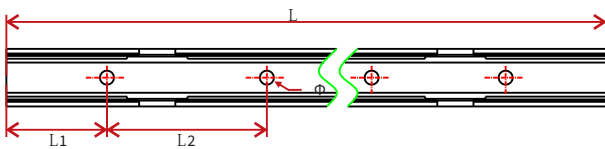
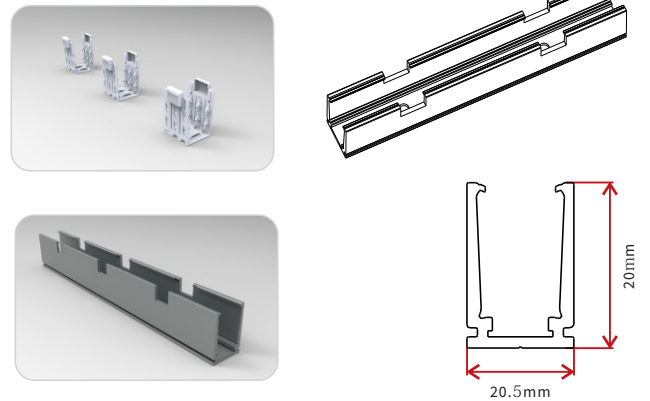

Model	W*H(mm)	Standard Length(mm)	L1(mm)	L2(mm)	L3(mm)	L4(mm)	Hole Screw(mm)	Hole Number	Clip Number
W22-SLA/PL	20.5 x 20	35	17.5	25	5	/	Ø3.5	2	1
		500	50	200	75	350	Ø3.5	3	2
		1000	100	200	150	350	Ø3.5	5	3
		2000	100	200	125	350	Ø3.5	10	6

## SELF-LOCKING ALUMINUM PROFILE VER. 2 (USING WITH THE CLIP)

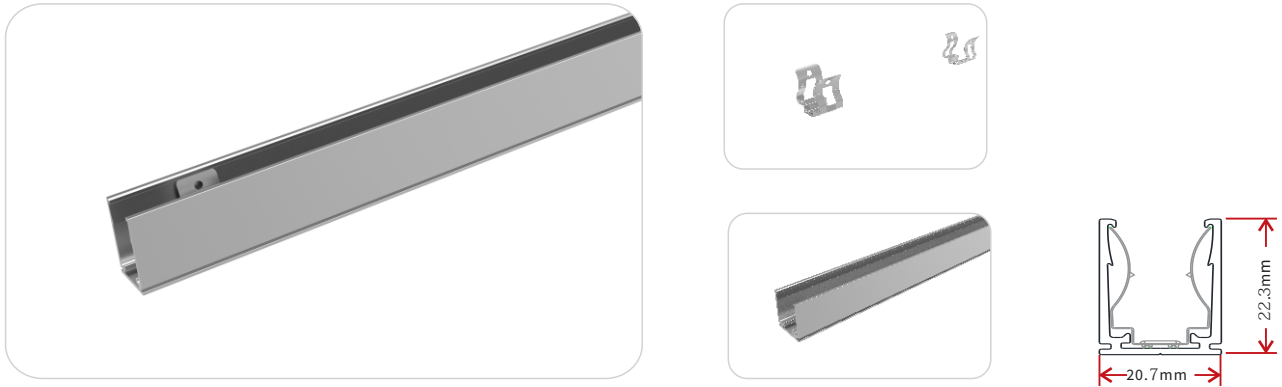

Note: Unless otherwise stated, the tolerance of the profile is  $\pm 0.5\text{mm}$ .

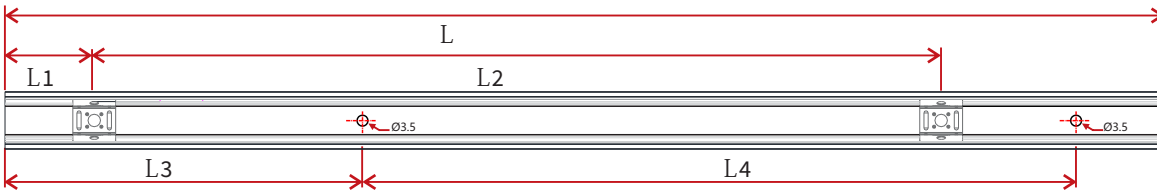

Model	W*H(mm)	Standard Length(mm)	L1(mm)	L2(mm)	L3(mm)	L4(mm)	Hole Screw(mm)	Hole Number	Clip Number
W22-SLA/PL2	20.7*22.3	35	17.5	/	5	25	Ø3.5	2	1
		500	25	150	50	200	Ø3.5	3	4
		1000	25	190	100	200	Ø3.5	5	6
		2000	25	195	100	200	Ø3.5	10	11

## PLASTIC & ALUMINUM COMBINATION PROFILE

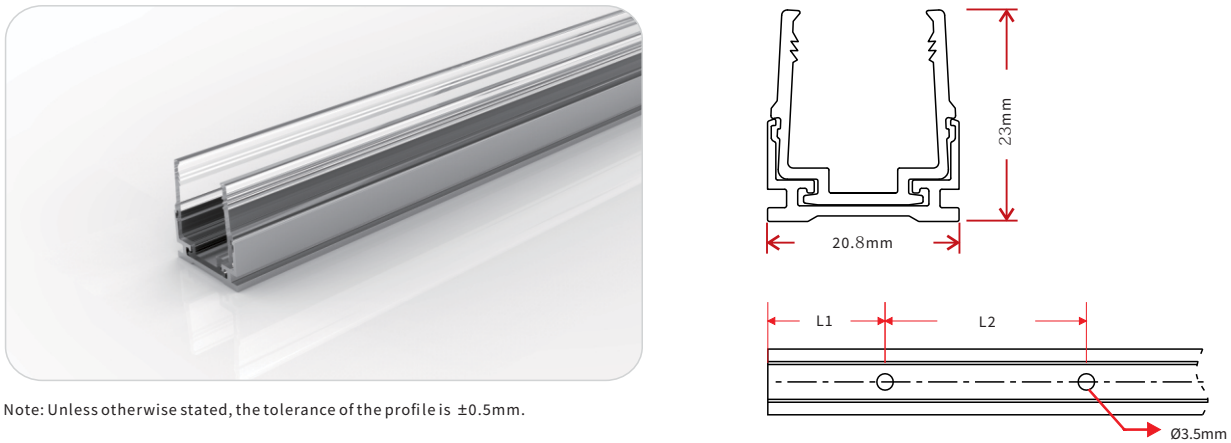

Note: Unless otherwise stated, the tolerance of the profile is  $\pm 0.5\text{mm}$ .

Model	W*H(mm)	Standard Length (mm)	L1 (mm)	L2 (mm)	Screw Hole (mm)	Hole Number	For Product
W22 -PA/PL	20.8*23	35	17.5	/	Ø3.5	1	W22
		500	50	200	Ø3.5	3	W22
		1000	100	200	Ø3.5	5	W22
		2000	100	200	Ø3.5	10	W22

## CABLE EXIT ORIENTED ALUMINUM PROFILE

(APPLICABLE TO INJECTION-MOULDED CONNECTOR ONLY)

### SELF-LOCKING ALUMINUM PROFILE VER. 2, BOTTOM FEED (USING WITH THE CLIP)

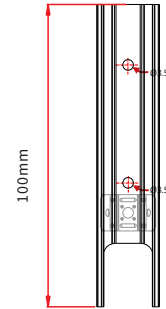
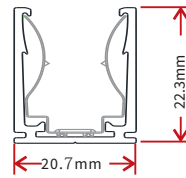
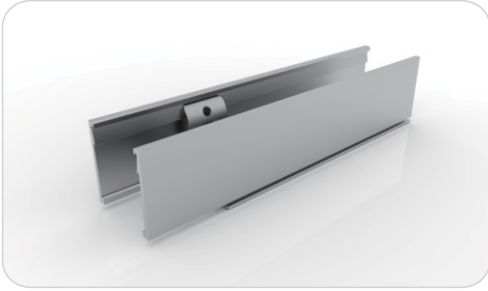

Model: W22-SLA/PL2-B

Note: Unless otherwise stated, the tolerance of the profile is  $\pm 0.5\text{mm}$ .

### SELF-LOCKING ALUMINUM PROFILE VER. 2, MIDDLE FEED (USING WITH THE CLIP)

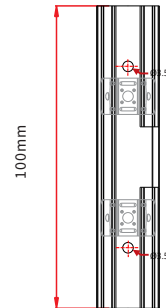
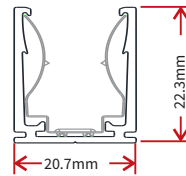
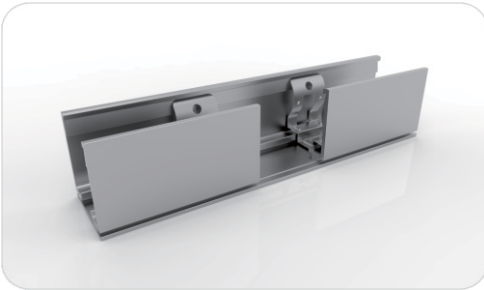

Model: W22-SLA/PL2-M

Note: Unless otherwise stated, the tolerance of the profile is  $\pm 0.5\text{mm}$ .

### SELF-LOCKING ALUMINUM PROFILE VER. 2, SIDE FEED FROM LEFT (USING WITH THE CLIP)

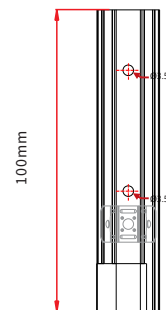
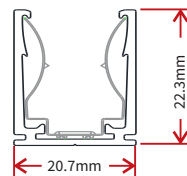
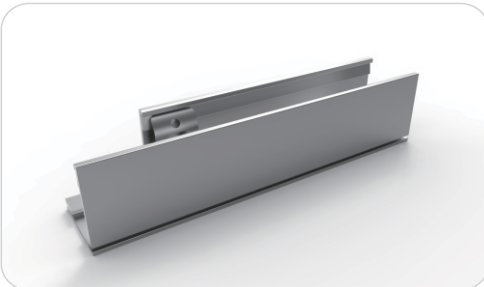

Model: W22-SLA/PL2-SL

Note: Unless otherwise stated, the tolerance of the profile is  $\pm 0.5\text{mm}$ .



## SELF-LOCKING ALUMINUM PROFILE VER. 2, SIDE FEED FROM RIGHT (USING WITH THE CLIP)

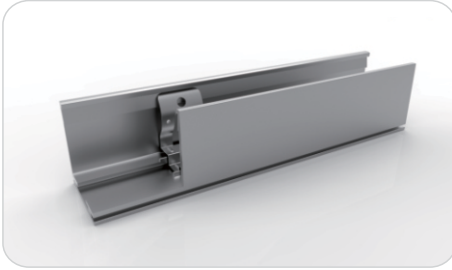

Model: W22-SLA/PL2-SR

Note: Unless otherwise stated, the tolerance of the profile is  $\pm 0.5\text{mm}$ .

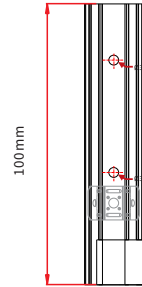
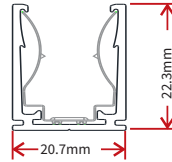

## CORNER ALUMINUM PROFILE

(APPLICABLE TO INJECTION-MOULDED CONNECTOR ONLY)

### L SHAPE SELF-LOCKING ALUMINUM PROFILE VER. 2 (USING WITH THE CLIP)

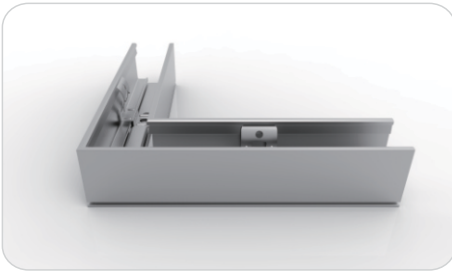

Model: W22-SLA/PL2-L

Note: Unless otherwise stated, the tolerance of the profile is  $\pm 0.5\text{mm}$ .

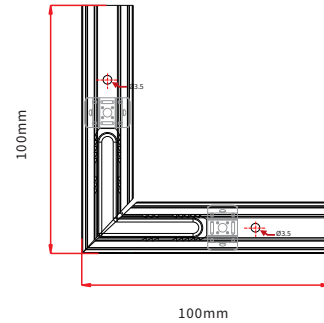
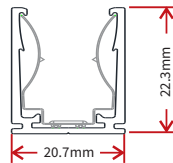

### INWARD L SHAPE SELF-LOCKING ALUMINUM PROFILE VER.2 (USING WITH THE CLIP)



Model: W22-SLA/PL2-IL

Note: Unless otherwise stated, the tolerance of the profile is  $\pm 0.5\text{mm}$ .

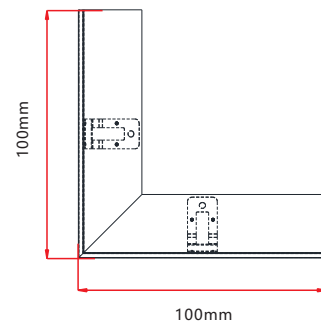
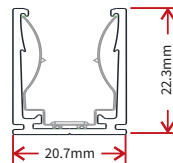

### OUTWARD L SHAPE SELF-LOCKING ALUMINUM PROFILE VER.2 (USING WITH THE CLIP)

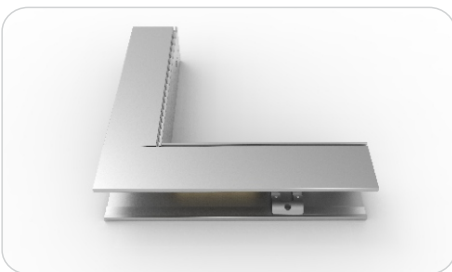

Model: W22-SLA/PL2-OL

Note: Unless otherwise stated, the tolerance of the profile is  $\pm 0.5\text{mm}$ .

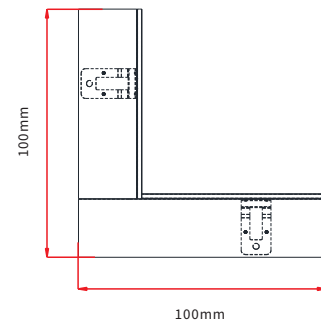
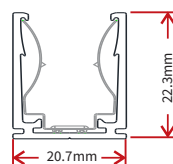

## T SHAPE SELF-LOCKING ALUMINUM PROFILE VER. 2 (USING WITH THE CLIP)

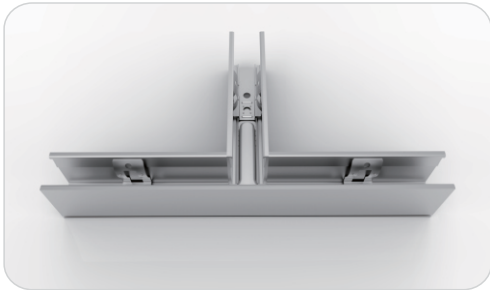

Model: W22-SLA/PL2-T

Note: Unless otherwise stated, the tolerance of the profile is  $\pm 0.5\text{mm}$ .

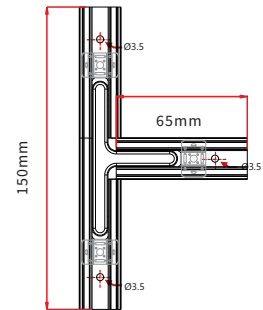
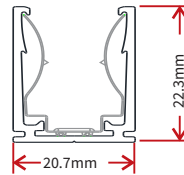

## X SHAPE SELF-LOCKING ALUMINUM PROFILE VER. 2 (USING WITH THE CLIP)



Model: W22-SLA/PL2-X

Note: Unless otherwise stated, the tolerance of the profile is  $\pm 0.5\text{mm}$ .

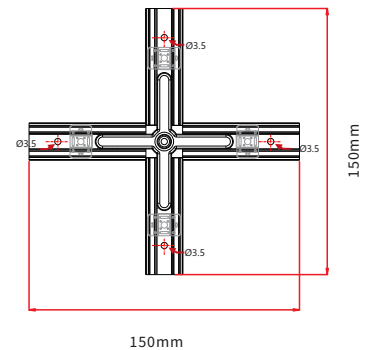
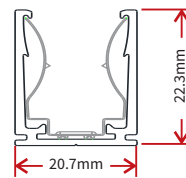

## CURVE STAINLESS STEEL PROFILE

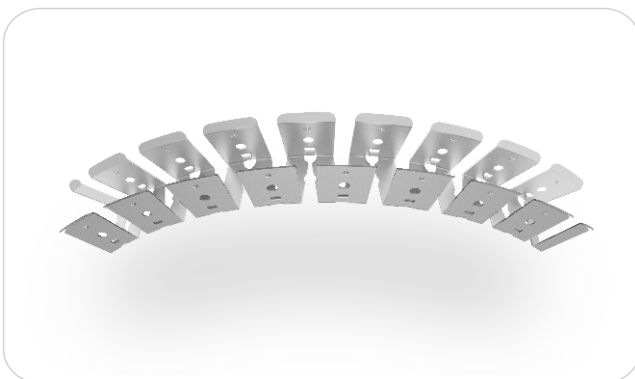

Model: W22-CS/PL

Note: Unless otherwise stated, the tolerance of the profile is  $\pm 0.5\text{mm}$ .

