



YYZ Vertex flex is designed to provide a very bright, crisp consistent and homogenized illumination that will accentuate any building, structure or artistic flourish. Using 84 high brightness surface mounted LEDs/meter, behind a first class eco-friendly UV-resistant PVC encapsulated flexible chamber material, it helps to provide bright, consistent traces of light in 10 shades of white, single colors of red, green and blue. The fixture consists of uniform and even lighting with no Led hotspot and has a transverse minimum diameter of 30cm. It is easy to be installed, can be cut and re connected with IP68 protected connector. Connectors at both ends offer ease of installation and is supplied in 5m standard rolls-or custom. Operating at 24V, the Vertex Flex features on-board constant-current drive topology, which ensures consistent brightness along the entire run, precise drive current, and long life expectancy. Dimming is achieved with YYZ's dimming compatible power supplies. Two power levels and two control types are also available.



FEATURES

LED QUANTITY	108 Leds / mtr
FINISH	PVC Encapsulated flexible chamber material
WORKING VOIAGE	24 Volts
RATED POWER	7.2W / 12W / mtr
RADIANCE ANGLE	160°
LAMP LIFE	50000 hrs
MOUNTING	Mounting clip / Chanel
CONNECTION	Outdoor rated connections
CUTTING INCREMENTS	7.2W / 83.3mm (1Unit), 12W / 55.6mm (1 Unit)
DIMENSIONS	17(H) x 16(W)
OPERATION TEMP	-20° C - +50°C
STORAGE TEMP	-20° C - +60° C
WEIGHT	0.325 kg/mtr
CONTINUOUS LENGTH	7.2W / 15mtr, 12W / 10mtr
DIMMING	Non dim, Dali, 0-10V by power supply

- 108 LEDs / mtr
LED Quality
- 24 VOLTS
Working Voltage
- 7.2 W / mtr & 12 W / mtr
Rated power

ELECTRICAL DATA

POWER CONSUMPTION	7.2W / 12W
SUPPLY VOIAGE	24 Volts
COLORS	2200K , 2700K, 3000K, 4000K, 5700K, 6500K, Red, Green, Blue, Amber
CRI	80+, 90+
LEDS / 3.3FT	108

ORDERING LOGIC

PRODUCT	BENDING	COLOR TEMPARTURE	WATTAGE	FIXTURE LENGTH	MOUNTING	CONNECTION	CUSTOM
VTF 7.2	VB - VERTICAL	(CT22)	2200K	7.2W	15 - 15Mtr (7.2W)	CLP - Clip	OC - Outdoor Connector xx
VTF 12		(CT27)	2700K	12W	10 - 10Mtr (12W) (####) CUSTOM	CHL - Chanel	
		(CT30)	3000K				
		(CT40)	4000K				
		(CT57)	5700K				
		(CT65)	6500K				
		(CTBL)	BLUE				
		(CTRD)	RED				
		(CTGR)	GREEN				
		(CTAM)	AMBER				
		(####)	CUSTOM				

(Connectors to Supply on Order)

Sample: VTF 7.2 - VB - CT22 - 7.2W - 15 - CLP - OC - XX

DIMENSION

Y22B-VB

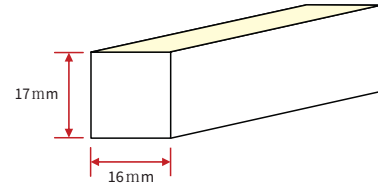
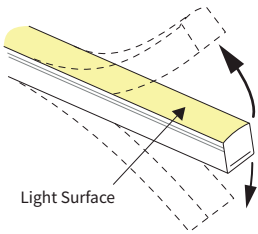

Note: Unless otherwise stated, the tolerance of the light is $\pm 0.3\text{mm}$.

BENDING DETAILS

Y22B-VB

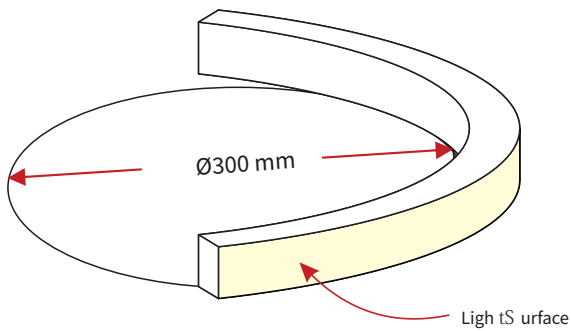

The light can only be bent along the light surface. Do not bend smaller than allowed minimum bend diameter.

TYPES OF CONNECTOR

INJECTION-MOULDED CONNECTOR

Note: Unless otherwise stated, the tolerance of the connector is $\pm 0.5\text{mm}$.



INJECTION-MOULDED FRONT CONNECTOR (BOTTOM)

Connects light to power supply with pre-installed bottom feed cable IP67. Available in 0.3m, 1m, 3m, 5m, 10m, 15m, 20m lengths.

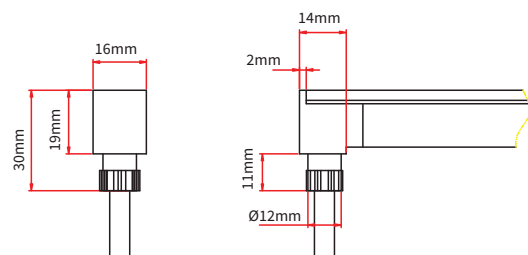

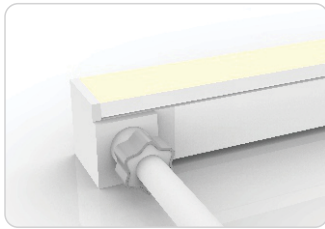

INJECTION-MOULDED FRONT CONNECTOR (SIDE)

Connects light to power supply with pre-installed side feed cable, IP67. Available in 0.3m, 1m, 3m, 5m, 10m, 15m, 20m lengths.

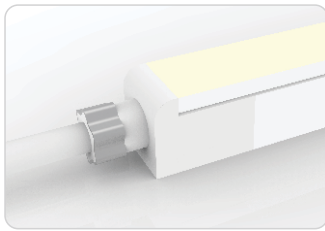
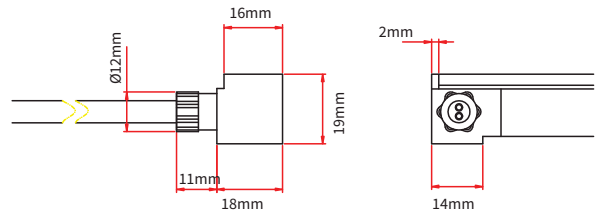

INJECTION-MOULDED FRONT CONNECTOR (END)

Connects light to power supply with pre-installed end feed cable, IP67. Available in 0.3m, 1m, 3m, 5m, 10m, 15m, 20m lengths.

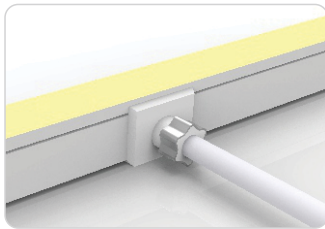
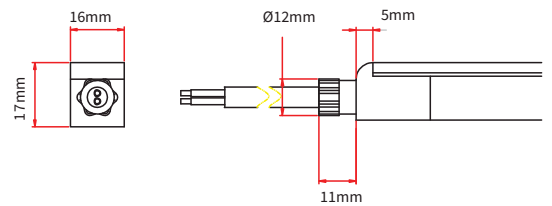

INJECTION-MOULDED MIDDLE FEED CONNECTOR

Connects light to power supply with pre-installed end feed cable, IP67. Available in 0.3m, 1m, 3m, 5m, 10m, 15m, 20m lengths.

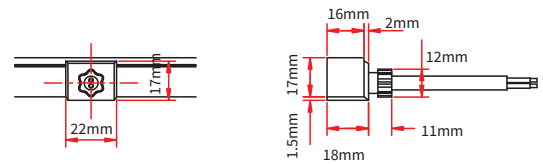

INJECTION-MOULDED END CAP

Pre-installed termination protection of the light, IP67.

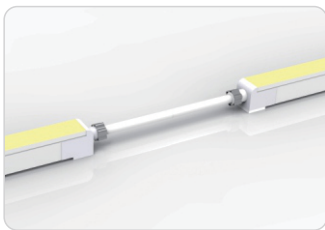
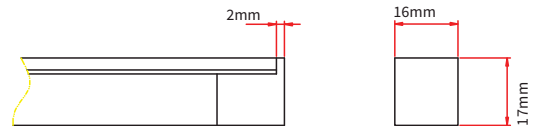

INJECTION-MOULDED JUMPER

Connects two pieces of lights together with a flexible cable. IP67 Injection-moulded connector. L available in 0.3-1m.

Maximum 8 Jumpers in 20m
Maximum 4 Jumpers in 10m

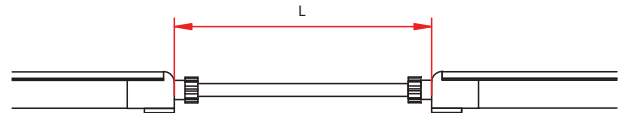

INJECTION-MOULDED T-FEED

Connects two pieces of lights together with a T joint, energized from middle. IP67 Injection-moulded connector. L1 and L2 available in 0.15-0.5m. L3 available in 0.3-3m.

Maximum 8 T-feeds in 20m
Maximum 4 T-feeds in 10m

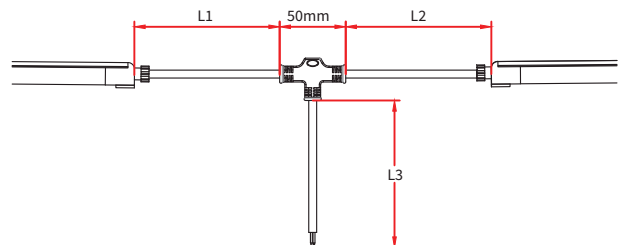

DUAL INJECTION-MOULDED CONNECTOR

Note: Unless otherwise stated, the tolerance of the connector is $\pm 0.5\text{mm}$.

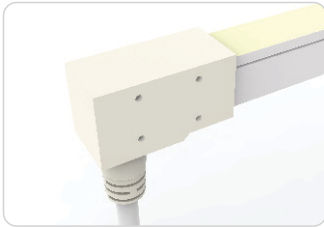

DUAL INJECTION-MOULDED FRONT CONNECTOR (BOTTOM)

Connects light to power supply with pre-installed bottom feed cable, IP68. Cable length available in 0.3m, 1m, 3m, 5m, 10m, 15m, 20m.

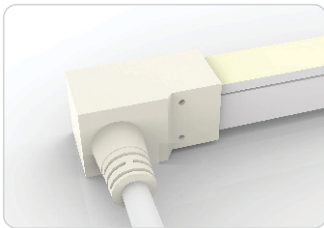
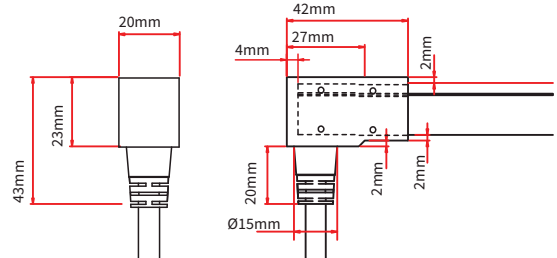

DUAL INJECTION-MOULDED FRONT CONNECTOR (SIDE)

Connects light to power supply with pre-installed side feed cable, IP68. Cable length available in 0.3m, 1m, 3m, 5m, 10m, 15m, 20m.

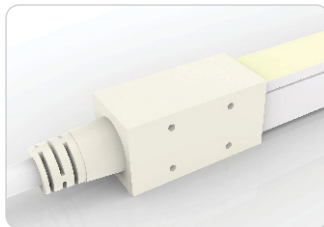
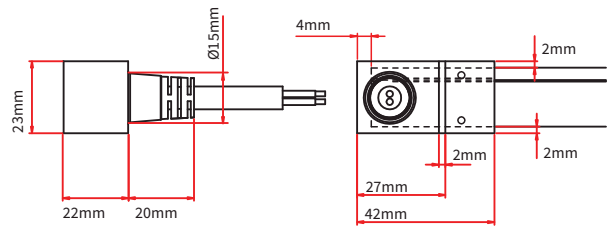

DUAL INJECTION-MOULDED FRONT CONNECTOR (TOP END)

Connects light to power supply with pre-installed end feed cable, IP68. Cable length available in 0.3m, 1m, 3m, 5m, 10m, 15m, 20m.

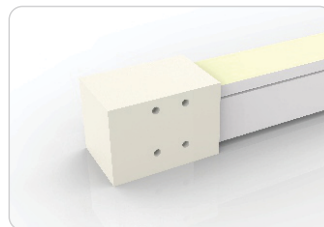
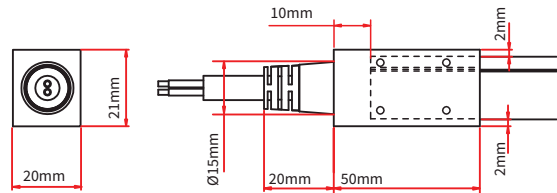

DUAL INJECTION-MOULDED END CAP

Pre-installed termination protection of the light, IP68.

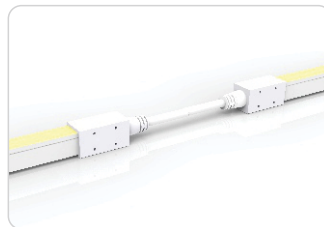
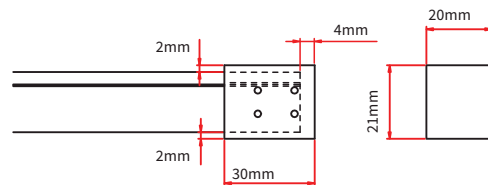

DUAL INJECTION-MOULDED JUMPER

Connects two pieces of lights together with a flexible cable. IP68 Dual Injection-moulded connector. L available in 0.3-1m.

Maximum 8 Jumpers in 20m
Maximum 4 Jumpers in 10m

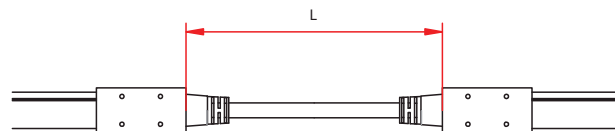

DUAL INJECTION-MOULDED T-FEED

Connects two pieces of lights together with a T joint, energized from middle. IP68 Dual Injection-moulded connector. L1 and L2 available in 0.15-0.5m. L3 available in 0.3-3m.

Maximum 8 T-feeds in 20m
Maximum 4 T-feeds in 10m

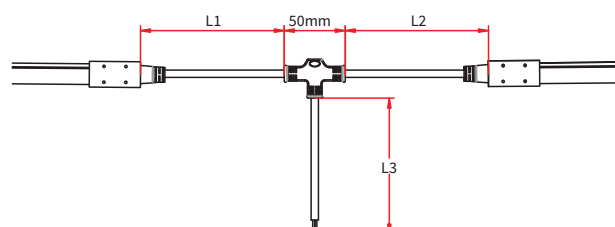

CLASP CONNECTOR

Note: Unless otherwise stated, the tolerance of the connector is $\pm 0.5\text{mm}$.

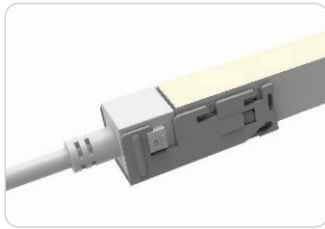

CLASP FRONT CONNECTOR

Connects light to power supply, IP67 DIY connector. Cable available in 0.3m, 1m, 3m, 5m, 10m, 15m, 20m lengths.

Feed connector with silicone gasket *1
(Two-pin)
Anti-skidding clip *1
U steel plate *1

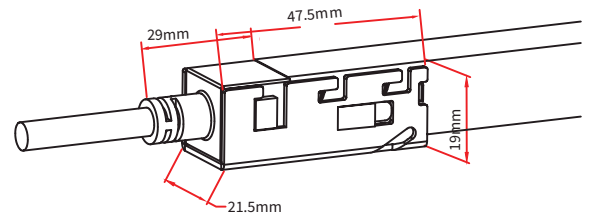

CLASP END CAP

Termination protection of the light, IP67 DIY connector.

Tail plug *1
Silicone gasket *1
Anti-skidding clip *1
U steel plate *1

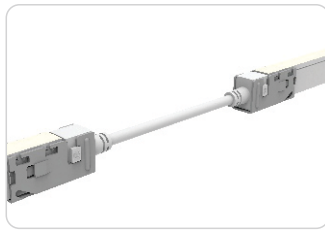
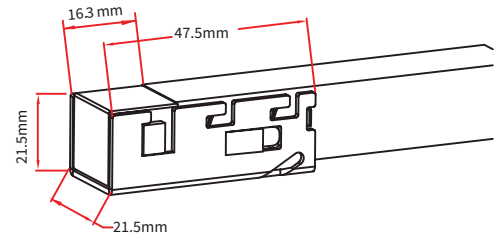

CLASP JUMPER

Connects two pieces of lights together with a flexible cable. IP67 DIY connector. L available in 0.3m, 1m and 3m.

Double-end feed connector *1 (Two-pin)
Silicone gasket *2
U steel plate *2
Anti-skidding clip *2

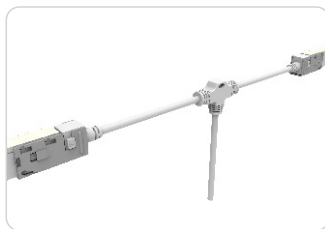
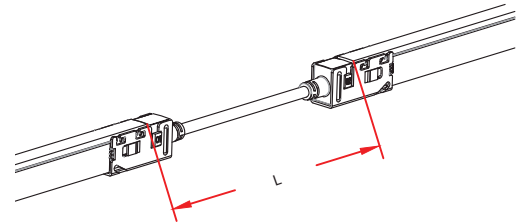

CLASP POWER T-FEED

Connects two pieces of lights together with a T joint, energized from middle. IP67 DIY connector. L1 and L2 available in 0.3m.

T joint *1 (Two-pin)
Silicone gasket *2
U steel plate *2
Anti-skidding clip *2

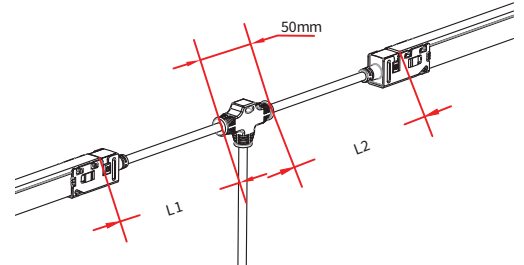

SNAP CONNECTOR

Note: Unless otherwise stated, the tolerance of the connector is $\pm 0.5\text{mm}$.

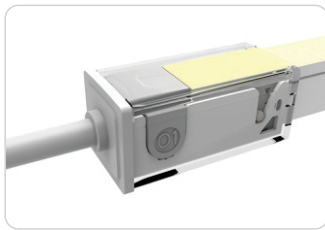

SNAP FRONT CONNECTOR(TOP END)

Connects light to power supply, IP67 DIY connector. Cable available in 0.3m, 1m, 3m, 5m, 10m, 15m, 20m lengths.

Feed connector with silicone gasket *1
(Two-pin)
Anti-skidding clip *1
U steel plate *1
PC Cover *1

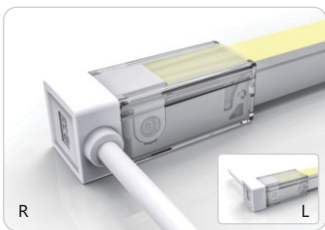
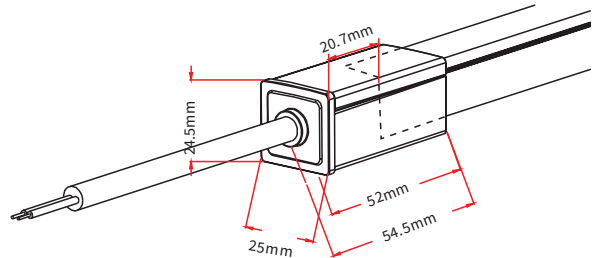

SNAP FRONT CONNECTOR(SIDE RIGHT/LEFT)

Connects light to power supply, IP67 DIY connector. Cable available in 0.3m, 1m, 3m, 5m, 10m, 15m, 20m lengths.

Feed connector with silicone gasket *1
(Two-pin)
Anti-skidding clip *1
U steel plate *1
PC Cover *1

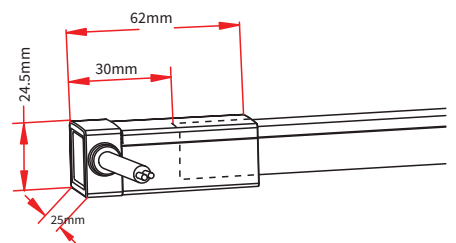

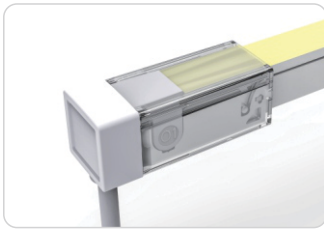

SNAP FRONT CONNECTOR(BOTTOM)

Connects light to power supply, IP67 DIY connector. Cable available in 0.3m, 1m, 3m, 5m, 10m, 15m, 20m lengths.

- Feed connector with silicone gasket *1 (Two-pin)
- Anti-skidding clip *1
- U steel plate *1
- PC Cover *1

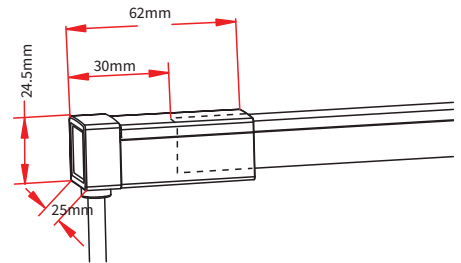

SNAP END CAP

Termination protection of the light, IP67 DIY connector.

- Tail plug with silicone gasket *1
- Anti-skidding clip *1
- U steel plate *1
- PC Cover *1

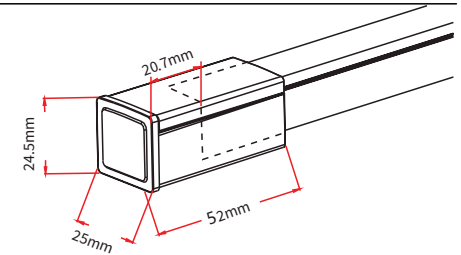

SNAP JUMPER

Connects two pieces of lights together with a flexible cable. IP67 DIY connector. L available in 0.3m, 1m and 3m.

- Double-end feed connector*1 (Two-pin)
- Silicone gasket*2
- U steel plate*2
- Anti-skidding clip*2
- PC cover*2

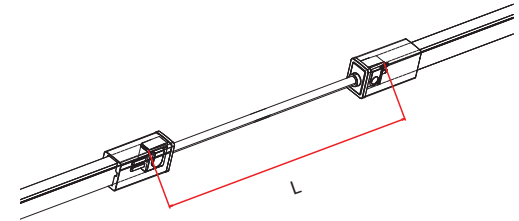

SNAP POWER T-FEED

Connects two pieces of lights together with a T joint, energized from middle. IP67 DIY connector. L1 and L2 available in 0.3m.

- T joint*1 (Two-pin)
- Silicone gasket*2
- U steel plate*2
- Anti-skidding clip*2
- PC cover*2

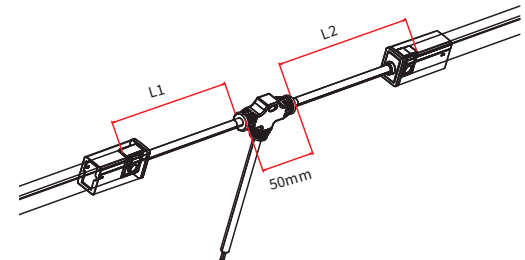

SWIVEL CONNECTOR

Note: Unless otherwise stated, the tolerance of the connector is $\pm 0.5\text{mm}$.

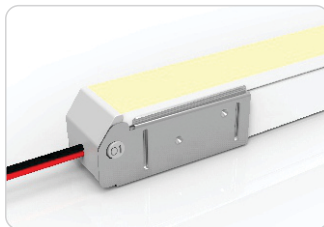

SWIVEL FRONT CONNECTOR (TOP END)

Connects light to power supply. IP20 DIY connector. Cable length available in 0.3m, 1m.

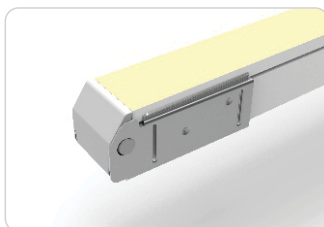
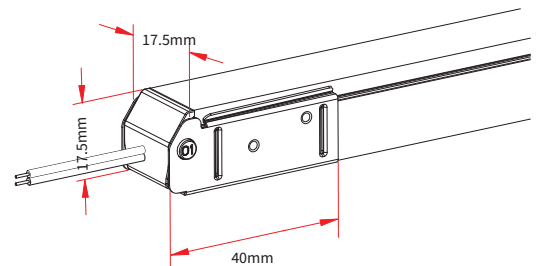

SWIVEL END CAP

Termination protection of the light, IP20 DIY connector.

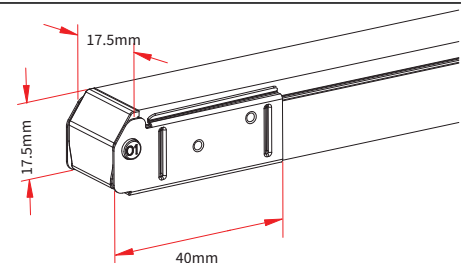

ANTI-WICKING FERRULE

Note: Unless otherwise stated, the tolerance is $\pm 0.5\text{mm}$.

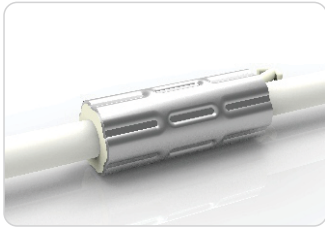

ANTI-WICKING FERRULE

The anti-wicking ferrule is located at 115mm ($\pm 5\text{mm}$ tolerance) from the connector on the cable.

For protection against water ingress from inside of cable wire and hence damage the light.

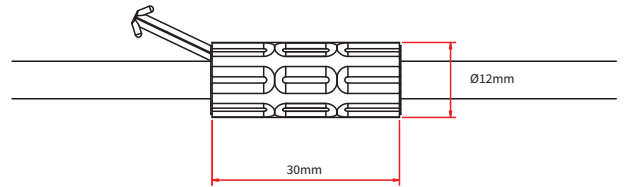

MALE & FEMALE CONNECTOR

Note: Unless otherwise stated, the tolerance is $\pm 2\text{mm}$.



MALE & FEMALE CONNECTOR

For plug and play cable junction, DIY or Pre-installed connector, IP68

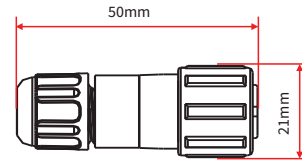

MOUNTING PROFILE

STANDARD ALUMINUM PROFILE

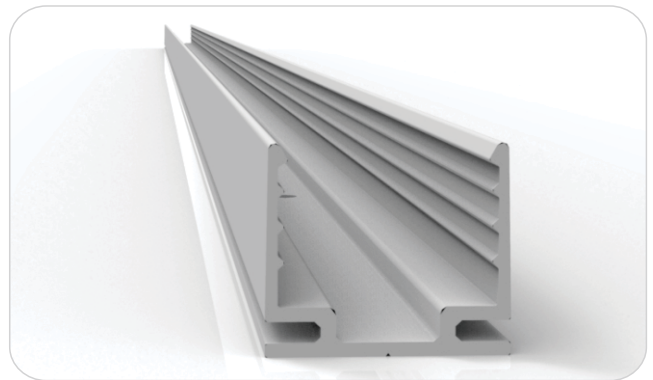
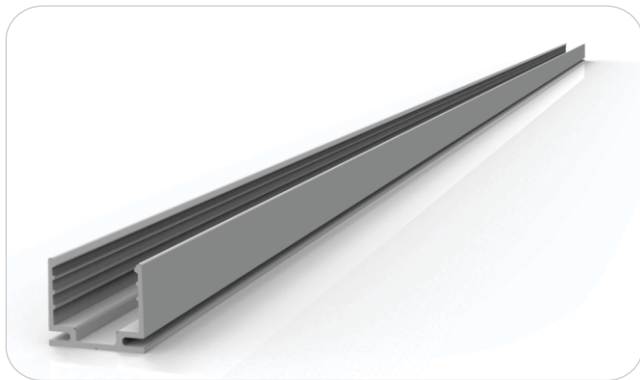

DIMENSIONS

Note: Unless otherwise stated, the tolerance of the profile is $\pm 0.5\text{mm}$.

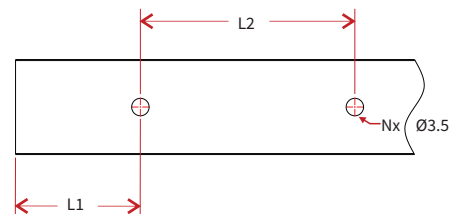
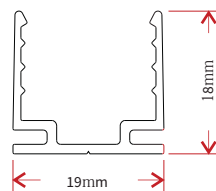
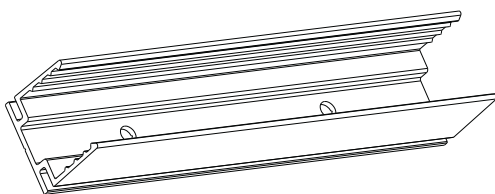

Model	W*H(mm)	Standard Length (mm)	L1 (mm)	L2 (mm)	Screw Hole (mm)	Hole Number	For Product
W22-A/PL	19*18	35	17.5	/	Ø3.5	1	W22
		500	50	200	Ø3.5	3	W22
		1000	100	200	Ø3.5	5	W22
		2000	100	200	Ø3.5	10	W22

PLASTIC PROFILE



Note: Unless otherwise stated, the tolerance of the profile is $\pm 0.5\text{mm}$.

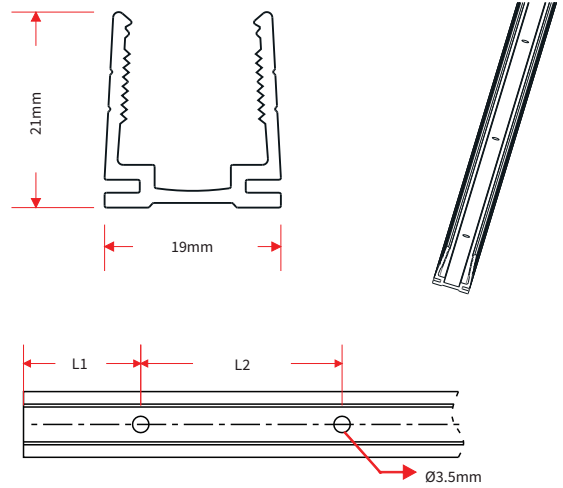

Model	W*H(mm)	Standard Length (mm)	L1 (mm)	L2 (mm)	Screw Hole (mm)	Hole Number	For Product
W22-PC/PL	19*21	500	50	200	$\varnothing 3.5$	3	W22
		1000	100	200	$\varnothing 3.5$	5	W22
		2000	100	200	$\varnothing 3.5$	10	W22

SELF-LOCKING ALUMINUM PROFILE (USING WITH THE CLIP)

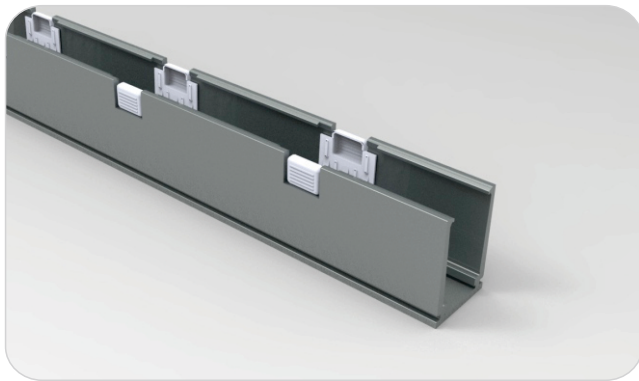

Note: Unless otherwise stated, the tolerance of the profile is $\pm 0.5\text{mm}$.

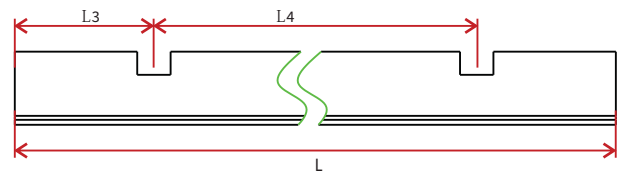
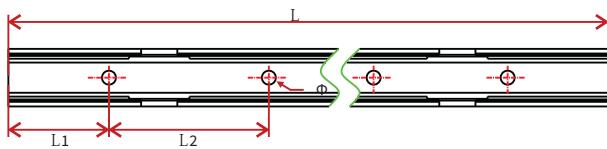
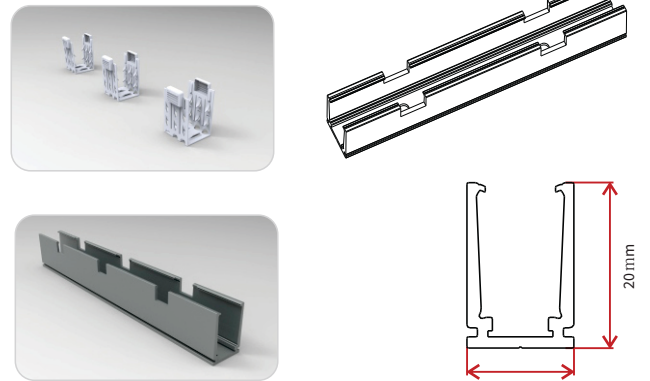

Model	W*H(mm)	Standard Length(mm)	L1(mm)	L2(mm)	L3(mm)	L4(mm)	Hole Screw(mm)	Hole Number	Clip Number
W22-SLA/PL	20.5 x 20	35	17.5	25	5	/	$\varnothing 3.5$	2	1
		500	50	200	75	350	$\varnothing 3.5$	3	2
		1000	100	200	150	350	$\varnothing 3.5$	5	3
		2000	100	200	125	350	$\varnothing 3.5$	10	6

SELF-LOCKING ALUMINUM PROFILE VER. 2 (USING WITH THE CLIP)

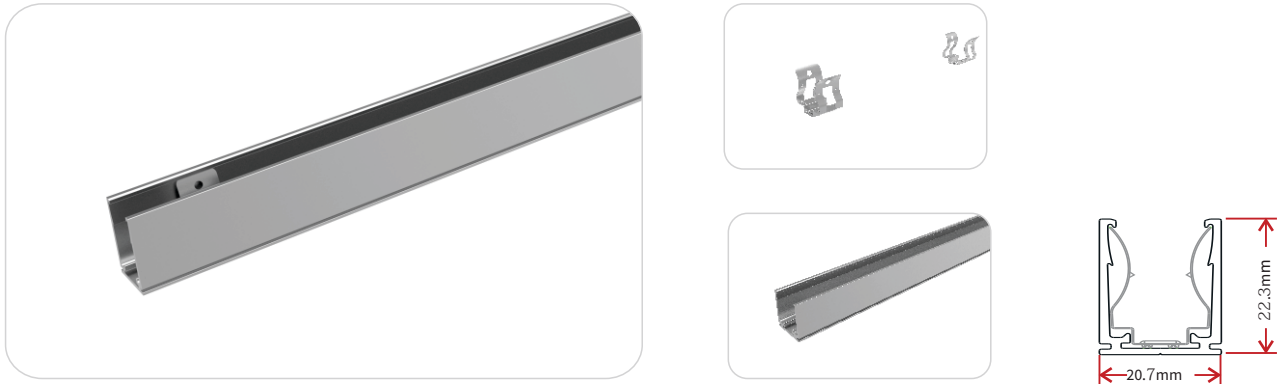

Note: Unless otherwise stated, the tolerance of the profile is $\pm 0.5\text{mm}$.

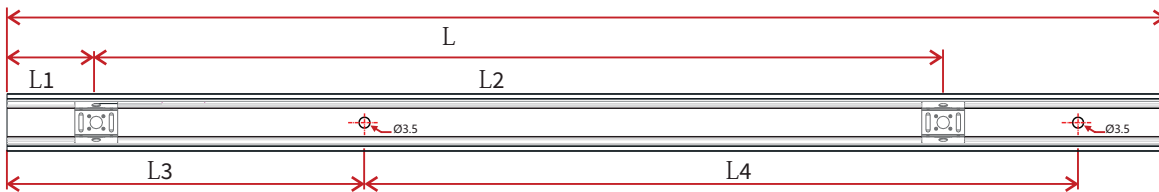

Model	W*H(mm)	Standard Length(mm)	L1(mm)	L2(mm)	L3(mm)	L4(mm)	Hole Screw(mm)	Hole Number	Clip Number
W22-SLA/PL2	20.7*22.3	35	17.5	/	5	25	Ø3.5	2	1
		500	25	150	50	200	Ø3.5	3	4
		1000	25	190	100	200	Ø3.5	5	6
		2000	25	195	100	200	Ø3.5	10	11

PLASTIC & ALUMINUM COMBINATION PROFILE

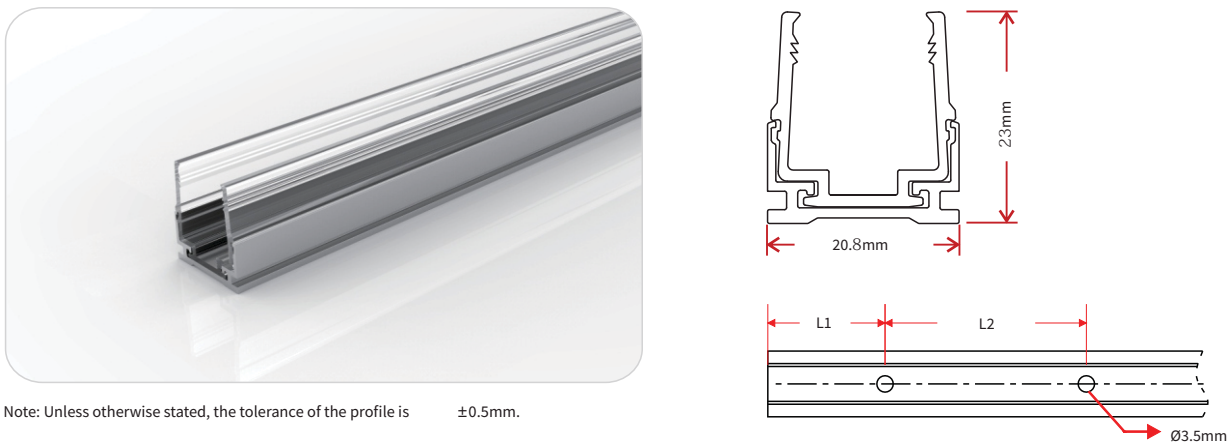

Note: Unless otherwise stated, the tolerance of the profile is $\pm 0.5\text{mm}$.

Model	W*H(mm)	Standard Length (mm)	L1 (mm)	L2 (mm)	Screw Hole (mm)	Hole Number	For Product
W22 -PA/PL	20.8*23	35	17.5	/	Ø3.5	1	W22
		500	50	200	Ø3.5	3	W22
		1000	100	200	Ø3.5	5	W22
		2000	100	200	Ø3.5	10	W22

CABLE EXIT ORIENTED ALUMINUM PROFILE (APPLICABLE TO INJECTION-MOULDED CONNECTOR ONLY)

SELF-LOCKING ALUMINUM PROFILE VER. 2, BOTTOM FEED (USING WITH THE CLIP)

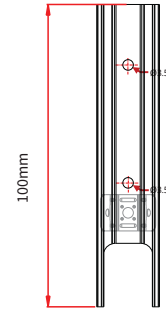
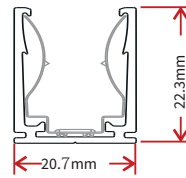
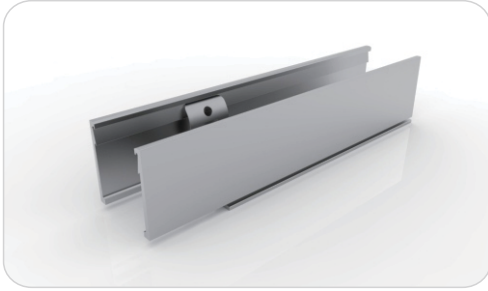

Model: W22-SLA/PL2-B

Note: Unless otherwise stated, the tolerance of the profile is $\pm 0.5\text{mm}$.

SELF-LOCKING ALUMINUM PROFILE VER. 2, MIDDLE FEED (USING WITH THE CLIP)

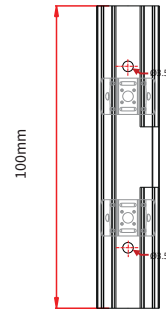
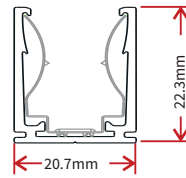
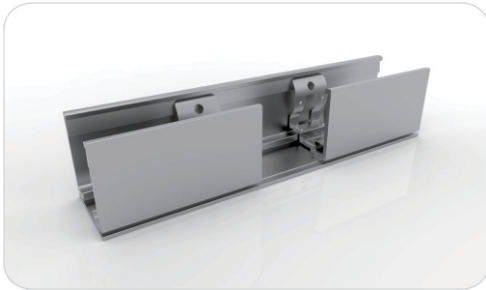

Model: W22-SLA/PL2-M

Note: Unless otherwise stated, the tolerance of the profile is $\pm 0.5\text{mm}$.

SELF-LOCKING ALUMINUM PROFILE VER. 2, SIDE FEED FROM LEFT (USING WITH THE CLIP)

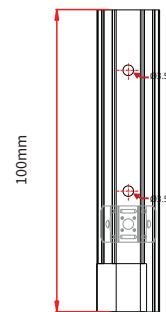
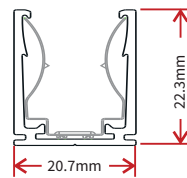
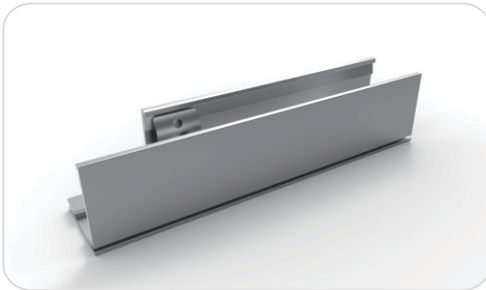

Model: W22-SLA/PL2-SL

Note: Unless otherwise stated, the tolerance of the profile is $\pm 0.5\text{mm}$.

SELF-LOCKING ALUMINUM PROFILE VER. 2, SIDE FEED FROM RIGHT (USING WITH THE CLIP)

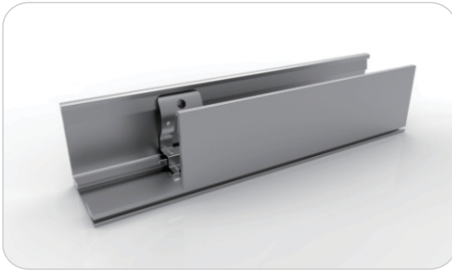

Model: W22-SLA/PL2-SR

Note: Unless otherwise stated, the tolerance of the profile is $\pm 0.5\text{mm}$.

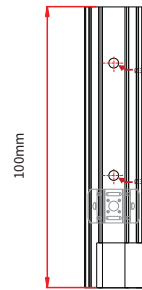
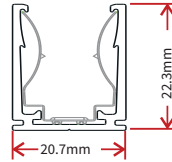

CORNER ALUMINUM PROFILE

(APPLICABLE TO INJECTION-MOULDED CONNECTOR ONLY)

L SHAPE SELF-LOCKING ALUMINUM PROFILE VER. 2 (USING WITH THE CLIP)

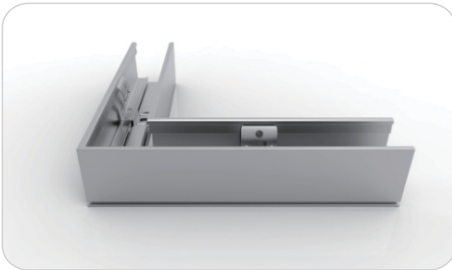

Model: W22-SLA/PL2-L

Note: Unless otherwise stated, the tolerance of the profile is $\pm 0.5\text{mm}$.

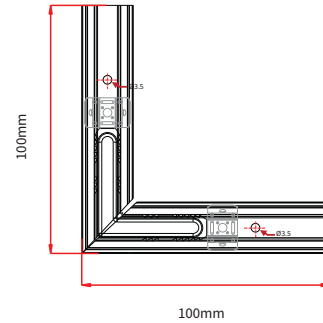
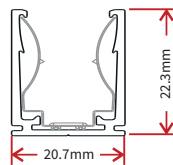

INWARD L SHAPE SELF-LOCKING ALUMINUM PROFILE VER.2 (USING WITH THE CLIP)



Model: W22-SLA/PL2-IL

Note: Unless otherwise stated, the tolerance of the profile is $\pm 0.5\text{mm}$.

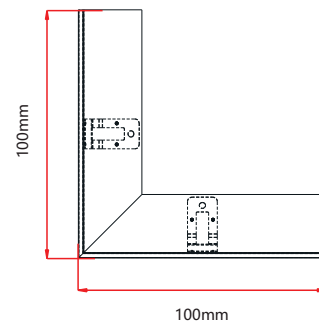
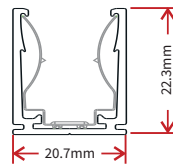

OUTWARD L SHAPE SELF-LOCKING ALUMINUM PROFILE VER.2 (USING WITH THE CLIP)



Model: W22-SLA/PL2-OL

Note: Unless otherwise stated, the tolerance of the profile is $\pm 0.5\text{mm}$.

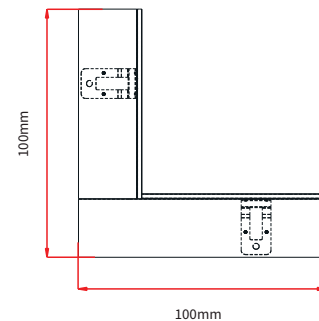
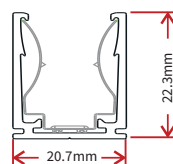

T SHAPE SELF-LOCKING ALUMINUM PROFILE VER. 2 (USING WITH THE CLIP)

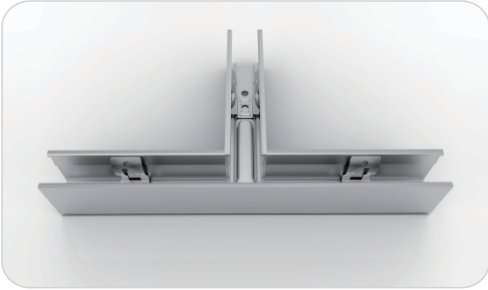

Model: W22-SLA/PL2-T

Note: Unless otherwise stated, the tolerance of the profile is $\pm 0.5\text{mm}$.

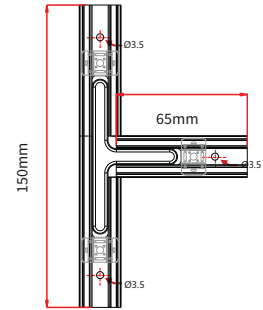
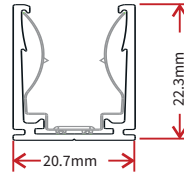

X SHAPE SELF-LOCKING ALUMINUM PROFILE VER. 2 (USING WITH THE CLIP)



Model: W22-SLA/PL2-X

Note: Unless otherwise stated, the tolerance of the profile is $\pm 0.5\text{mm}$.

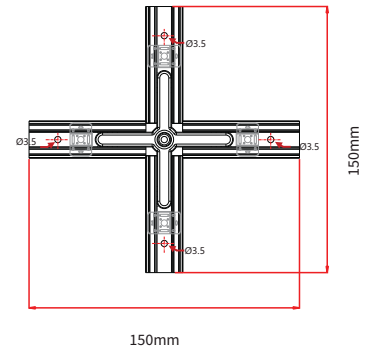
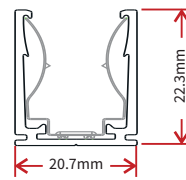

CURVE STAINLESS STEEL PROFILE



Model: W22-CS/PL

Note: Unless otherwise stated, the tolerance of the profile is $\pm 0.5\text{mm}$.

