

# VERTEX FLEX-Y23B-HB-24V



YYZ Vertex flex is designed to provide a very bright, crisp consistent and homogenized illumination that will accentuate any building, structure or artistic flourish. Using 84 high brightness surface mounted LEDs/meter, behind a first class eco-friendly UV-resistant PVC encapsulated flexible chamber material, it helps to provide bright, consistent traces of light in 10 shades of white, single colors of red, green and blue. The fixture consists of uniform and even lighting with no Led hotspot and has a transverse minimum diameter of 30cm. It is easy to be installed, can be cut and re connected with IP68 protected connector. Connectors at both ends offer ease of installation and is supplied in 5m standard rolls-or custom. Operating at 24V, the Vertex Flex features on-board constant-current drive topology, which ensures consistent brightness along the entire run, precise drive current, and long life expectancy. Dimming is achieved with YYZ's dimming compatible power supplies. Two power levels and two control types are also available.



## FEATURES

LED QUANTITY	144 Leds / mtr
FINISH	PVC Encapsulated flexible chamber material
WORKING VOLTAGE	24 Volts
RATED POWER	4.5W/ mtr
RADIANCE ANGLE	160°
LAMP LIFE	50000 hrs
MOUNTING	Mounting clip / Chanel
CONNECTION	Outdoor rated connections
CUTTING INCREMENTS	83.3mm (1Unit)
DIMENSIONS	10(H) x 10(W)
OPERATION TEMP	-20° C - +50° C
STORAGE TEMP	-20° C - +60° C
WEIGHT	0.140 kg/mtr
CONTINUOUS LENGTH	10mtr
DIMMING	Non dim, Dali, 0-10V By power supply

- 144 LEDs / mtr  
LED Quality
- 24 VOLTS  
Working Voltage
- 4.5 W / mtr  
Rated power

## ELECTRICAL DATA

POWER CONSUMPTION	4.5W
SUPPLY VOLTAGE	24 Volts
COLORS	2200K , 2700K, 3000K, 4000K, 5700K, Red, Green, Blue, Amber
CRI	80+
LEDS / 3.3FT	144

## ORDERING LOGIC

PRODUCT	BENDING	COLOR TEMPARTURE	WATTAGE	FIXTURE LENGTH	MOUNTING	CONNECTION	CUSTOM
VERTEX FLEX Y23B - (VTF Y23B)	HB - HORIZONTAL	(CT22)	2200K	04.50 - 4.5W/Mtr	10 - 10Mtr	CLP - Clip CHL - Chanel	OC - Outdoor Connector xx
		(CT27)	2700K		(####) CUSTOM		
		(CT30)	3000K				
		(CT40)	4000K				
		(CT57)	5700K				
		(CTBL)	BLUE				
		(CTRD)	RED				
		(CTGR)	GREEN				
		(CTAM)	AMBER				
		(####)	CUSTOM				

(Connectors to Supply on Order)

Sample: VTF Y23B - HB - CT22 - 04.50 - 10 - CLP - OC - XX

## DIMENSION

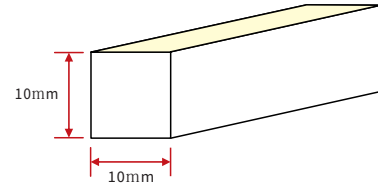
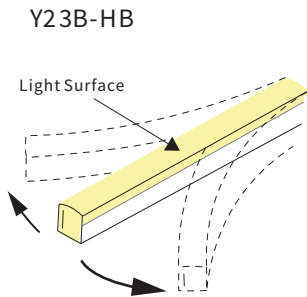

Note: Unless otherwise stated, the tolerance of the light is  $\pm 0.3\text{mm}$ .

## BENDING DETAILS

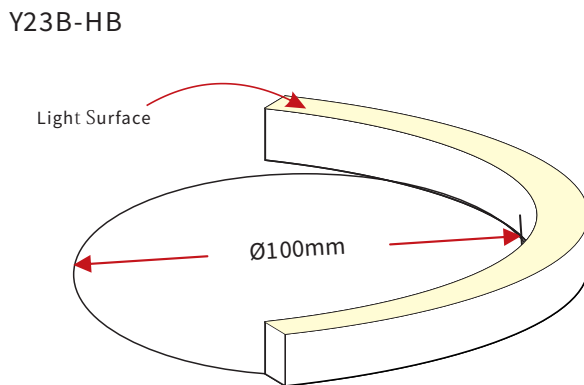

The light can only be bent along the light surface. Do not bend smaller than allowed minimum bend diameter.

## TYPES OF CONNECTOR

### INJECTION-MOULDED CONNECTOR

Note: Unless otherwise stated, the tolerance of the connector is  $\pm 0.5\text{mm}$ .

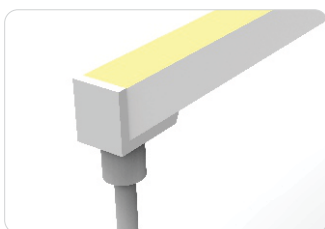

#### INJECTION-MOULDED FRONT CONNECTOR (BOTTOM)

Connects light to power supply with pre-installed bottom feed cable IP40. Cable length available in 0.3m, 1m, 3m, 5m, 10m, 15m, 20m lengths.

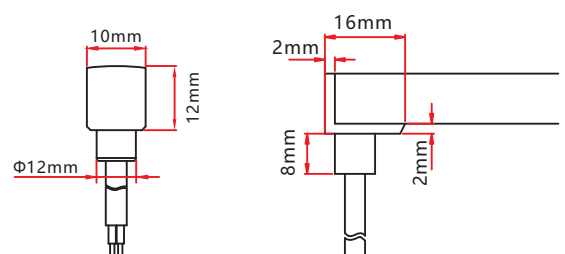

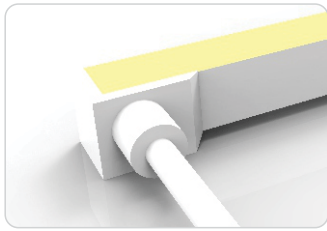

### INJECTION-MOULDED FRONT CONNECTOR (SIDE)

Connects light to power supply with pre-installed side feed cable, IP40. Cable length available in 0.3m, 1m, 3m, 5m, 10m, 15m, 20m lengths.

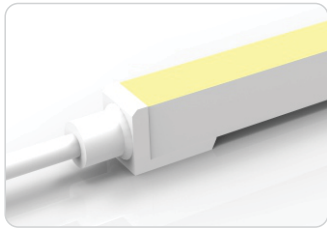
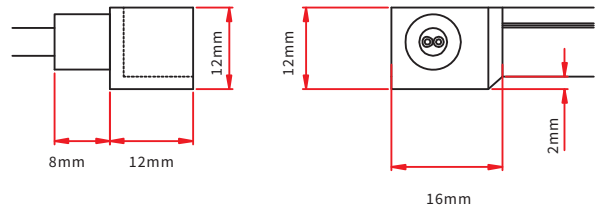

### INJECTION-MOULDED FRONT CONNECTOR (END)

Connects light to power supply with pre-installed end feed cable, IP40. Cable length available in 0.3m, 1m, 3m, 5m, 10m, 15m, 20m lengths.

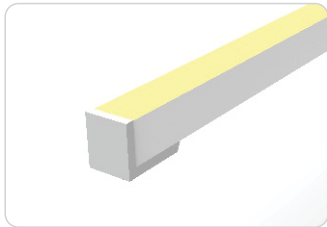
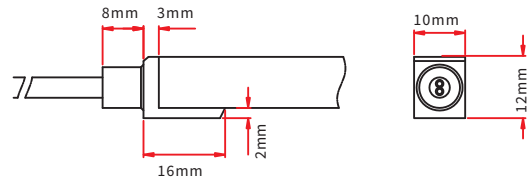

### INJECTION-MOULDED END CAP

Pre-installed termination protection of the light, IP40.

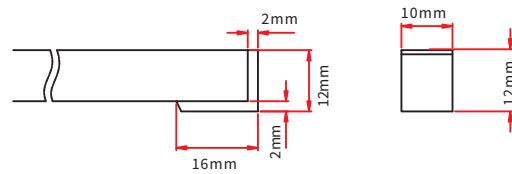

## DUAL INJECTION-MOULDED CONNECTOR

Note: Unless otherwise stated, the tolerance of the connector is  $\pm 0.5\text{mm}$ .



### DUAL INJECTION-MOULDED FRONT CONNECTOR (BOTTOM)

Connects light to power supply with pre-installed bottom feed cable, IP65. Cable length available in 0.3m, 1m, 3m, 5m, 10m, 15m, 20m.

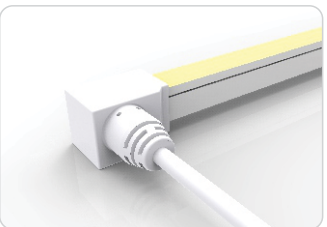
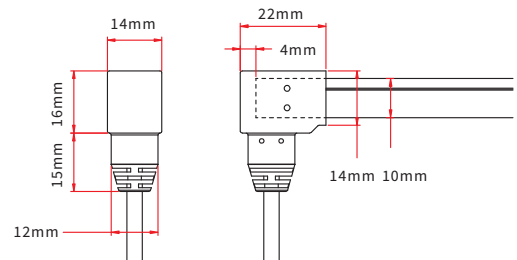

### DUAL INJECTION-MOULDED FRONT CONNECTOR (SIDE)

Connects light to power supply with pre-installed side feed cable, IP65. Cable length available in 0.3m, 1m, 3m, 5m, 10m, 15m, 20m.

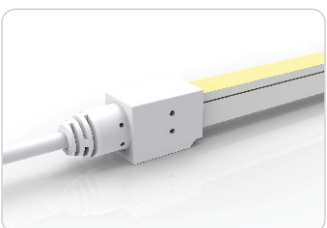
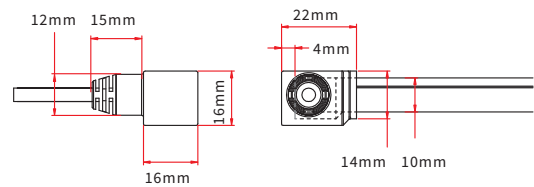

### DUAL INJECTION-MOULDED FRONT CONNECTOR (TOP END)

Connects light to power supply with pre-installed end feed cable, IP65. Cable length available in 0.3m, 1m, 3m, 5m, 10m, 15m, 20m.

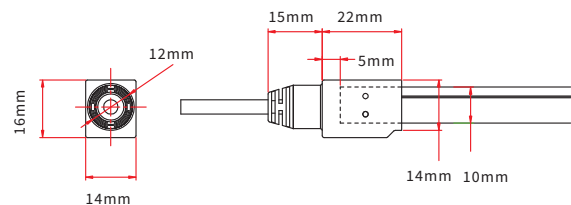

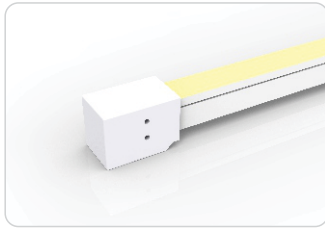

### DUAL INJECTION-MOULDED END CAP

Pre-installed termination protection of the light, IP65.

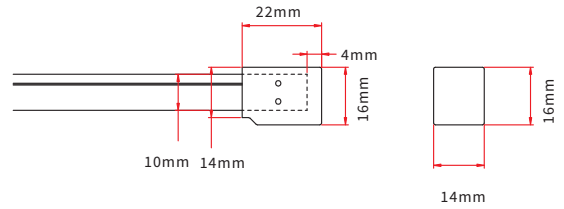

## SWIVEL CONNECTOR

Note: Unless otherwise stated, the tolerance of the connector is  $\pm 0.5\text{mm}$ .

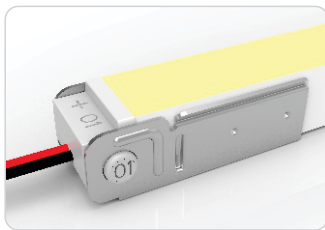

### SWIVEL FRONT CONNECTOR (TOP END)

Connects light to power supply, IP20. DIY connector. Cable available in 0.3m, 1m lengths.

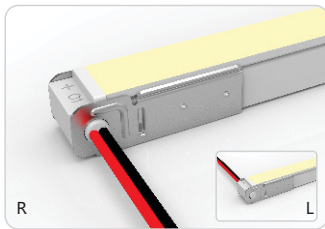
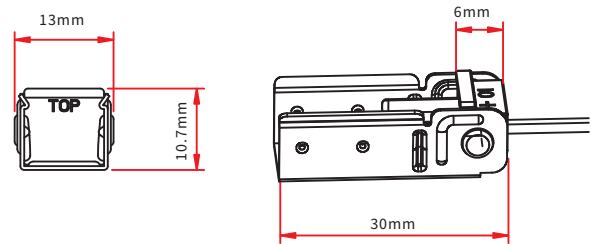

### SWIVEL FRONT CONNECTOR (SIDE RIGHT/LEFT)

Connects light to power supply, IP20. DIY connector. Cable available in 0.3m, 1m lengths.

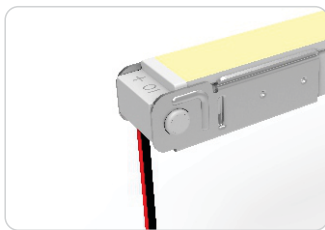
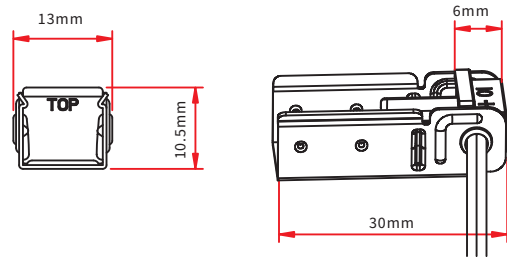

### SWIVEL FRONT CONNECTOR (bottom)

Connects light to power supply, IP20. DIY connector. Cable available in 0.3m, 1m lengths.

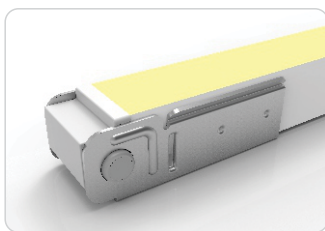
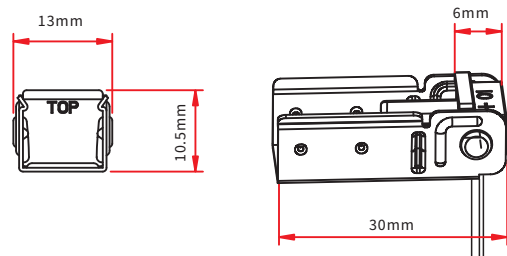

### SWIVEL END CAP

Termination protection of the light, IP20 DIY connector.

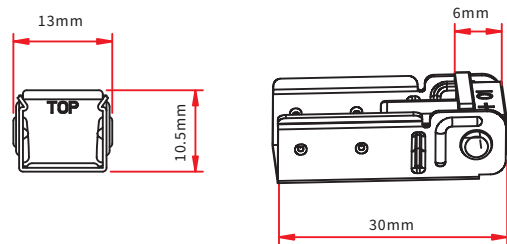

## MALE & FEMALE CONNECTOR

Note: Unless otherwise stated, the tolerance is  $\pm 2\text{mm}$ .



### MALE & FEMALE CONNECTOR

For plug and play cable junction, DIY or Pre-installed connector, IP68

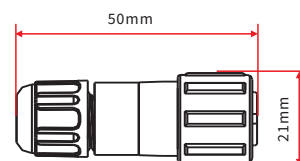

## MOUNTING PROFILE

### PLASTIC & ALUMINUM COMBINATION PROFILE

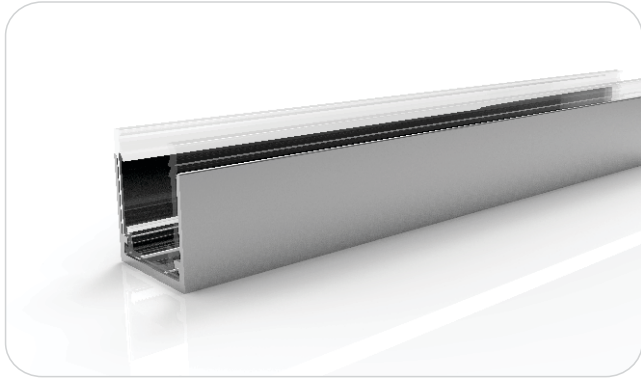

Note: Unless otherwise stated, the tolerance of the profile is  $\pm 0.5\text{mm}$ .

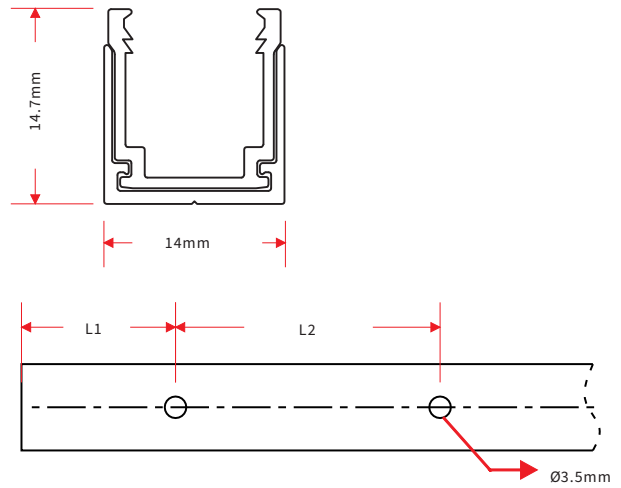

Model	W*H(mm)	Standard Length (mm)	L1 (mm)	L2 (mm)	Screw Hole (mm)	Hole Number	For Product
F23 - PA/PL	14*14.7	35	17.5	/	$\varnothing 3.5$	1	F23
		500	50	200	$\varnothing 3.5$	3	F23
		1000	100	200	$\varnothing 3.5$	5	F23
		2000	100	200	$\varnothing 3.5$	10	F23