

PEARL SERIES

PRL 85

Mono IP20 CE

YYZ Pearl series of architectural downlight features glare free performance with UGR ≤ 17 even for the ultra wide beam angle. Available in variety of sizes to accommodate wattage range from 6.5W to 28W making it versatile for applications with ceiling heights ranging from 2.8 to 10 meter.

FEATURES

MATERIAL	Die-cast aluminum
FINISH	White, Black
RATED POWER	10.5W
WORKING VOLTAGE	24V DC
RADIANCE ANGLE	15°, 24°, 38°
MOUNTING	Ceiling recessed
CONNECTION	Indoor rated connections
LAMP LIFE	50,000 Hrs
DIMENSION	Ø85 x 76mm (Cutout Ø75mm)
OPERATING TEMP	-20° C - +50° C
CONTROL	On/Off



LEDTEEN
LED Quality

24V DC
Working Voltage

10.5W
Rated power

ELECTRICAL DATA

POWER CONSUMPTION	10.5W
SUPPLY VOLTAGE	220-240V AC
COLORS	2700K, 3000K, 4000K
CRI	80, 90
LUMEN	630lm

DIMENSIONS

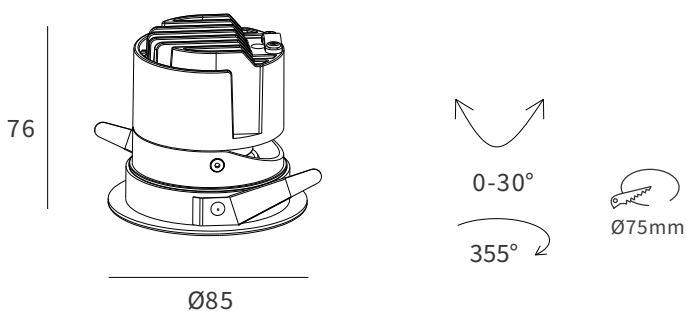

ORDERING LOGIC

PRODUCT	WATTAGE	COLOR TEMPERATURE	BEAM ANGLE	FINISH	
PRL 85	10.5 - 10.5W	(CT27)	2700K	15 - 15°	BK - Black
		(CT30)	3000K	24 - 24°	WH - White
		(CT40)	4000K	38 - 38°	XX - Custom

Sample: PRL 85 - 10.5 - CT27 - 15 - BK