

TINY SPOT LIGHT

TNY 2111

Mono IP54 CE

YYZ Tiny spot lights are miniature downlights in die-cast aluminum housing which are designed for wet area applications like jacuzzi, toilets, balcony, exterior entrance that demands water proof construction and resistance to corrosion. These recessed ceiling-mounted downlights with symmetrical light distribution to achieve an effective task or ambient lighting.



FEATURES

MATERIAL	Die-cast aluminum
FINISH	White, Black
RATED POWER	10W
WORKING CURRENT	500mA
RADIANCE ANGLE	15°, 24°, 36°, 55°
MOUNTING	Ceiling recessed mounted
CONNECTION	Indoor rated connections
LAMP LIFE	50,000 Hrs
DIMENSION	Ø74 x 94mm(CutoutØ68mm)
OPERATING TEMP	-20° C - +50° C
CONTROL	On/Off

CREE LED Quality

500mA Working Current

10W Rated power

ELECTRICAL DATA

POWER CONSUMPTION	10W
SUPPLY VOLTAGE	230V AC
COLORS	2700K, 3000K, 4000K
CRI	≥92
LUMEN	900lm

DIMENSIONS

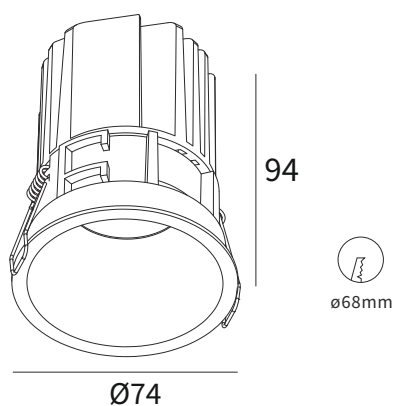

ORDERING LOGIC

PRODUCT	WATTAGE	COLOR TEMPERATURE	BEAM ANGLE	FINISH	CUSTOM	
TNY2111	10 - 10W	(CT27)	2700K	15 - 15°	WH - White	xx
		(CT30)	3000K	24 - 24°	BK - Black	
		(CT40)	4000K	36 - 36°		
				55 - 55°		

Sample: TNY 2111 - 10 - CT27 - 15 - WH - XX