

HOLDER

HLD-SQ15

Mono IP20 CE

YYZ Holder Square series are miniature downlights in square profile with choice of 1,2 to 5 lamps. These downlights are with symmetrical light distribution which help us to accurately orient towards illuminating objects. The finishes available have the light fitting heads in white and black.

FEATURES

MATERIAL	Aluminum
FINISH	White, Black
RATED POWER	3x5W
WORKING CURRENT	500mA
RADIANCE ANGLE	15°, 24°, 38°, 50°
MOUNTING	Ceiling recessed
CONNECTION	Indoor rated connections
LAMP LIFE	50,000 Hrs
DIMENSION	127 x 62 x 57mm (cutout 150x57mm)
OPERATING TEMP	-20° C - +50° C
CONTROL	On/Off, 1-10V, Dali



CITIZEN
LED Quality

500mA
Working Current

3x5W
Rated power

ELECTRICAL DATA

POWER CONSUMPTION	3x5W
SUPPLY VOLTAGE	220-240VAC
COLORS	2700K, 3000K, 4000K
CRI	90+
LUMEN	3x480 lm

DIMENSIONS

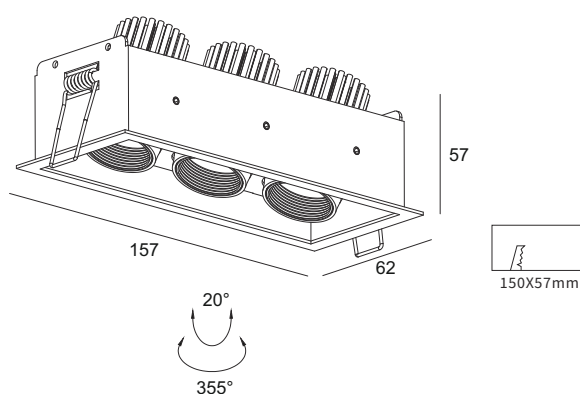

ORDERING LOGIC

PRODUCT	COLOR TEMPERATURE	WATTAGE	BEAM ANGLE	BODY FINISH	CUSTOM
HLD-SQ15	(CT27)	2700K	15 - 15°	BK - Black	XX - XXX
	(CT30)	3000K	24 - 24°	WH - White	
	(CT40)	4000K	38 - 38°		
			50 - 50°		

Sample: HLD-SQ15 - CT27 - 15 - 15 - BK - XX