

WALLWASHER LWO SERIES

LWO-30



FACADE INSTALLATION

1. As shown in image 1, rotate the lighting fixture to the position shown in the image 1, and fix the bracket on the facade with M6 x 60mm metal expansion screws.
2. As shown in image 2, after the bracket is fixed, rotate the lighting fixture to the appropriate projection Angle, use the 6mm hexagonal wrench to fix the M8 inner hexagonal cylindrical head bolt on the rotating shaft, connect the male and female together.

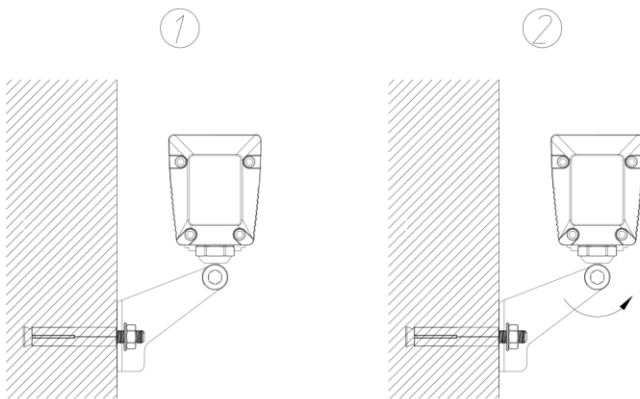

HORIZONTAL INSTALLATION

1. As shown in image 1, rotate the lighting fixture to the position shown in the figure 1, and fix the bracket on the floor with M6 x 60mm metal expansion screws
2. As shown in image 2, after the bracket is fixed, rotate the lighting fixture to the appropriate projection Angle, use the 6mm hexagonal wrench to fix the M8 inner hexagonal cylindrical head bolt on the rotating shaft, connect the male and female together.

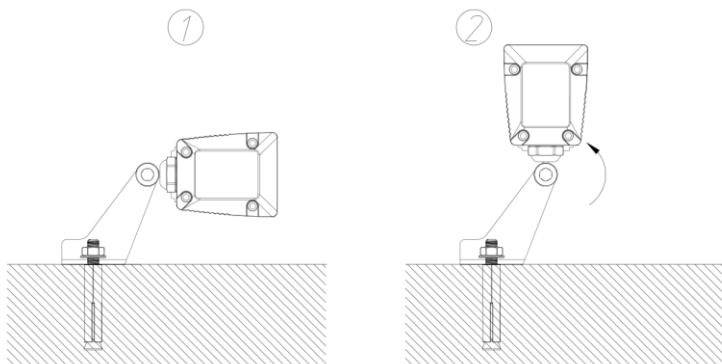

DIAGRAM

